



for a greener tomorrow



**MITSUBISHI
ELECTRIC**

Changes for the Better

FACTORY AUTOMATION

Mitsubishi Electric Servo System Family Catalog

Leading the World with the industry's Top Class Technology

MITSUBISHI SERVO AMPLIFIERS & MOTORS

MELSERVO SYSTEM



GLOBAL IMPACT OF MITSUBISHI ELECTRIC



Through Mitsubishi Electric's vision, "Changes for the Better" are possible for a brighter future.

Changes for the Better

We bring together the best minds to create the best technologies. At Mitsubishi Electric, we understand that technology is the driving force of change in our lives. By bringing greater comfort to daily life, maximizing the efficiency of businesses and keeping things running across society, we integrate technology and innovation to bring changes for the better.

Mitsubishi Electric is involved in many areas including the following

Energy and Electric Systems

A wide range of power and electrical products from generators to large-scale displays.

Electronic Devices

A wide portfolio of cutting-edge semiconductor devices for systems and products.

Home Appliance

Dependable consumer products like air conditioners and home entertainment systems.

Information and Communication Systems

Commercial and consumer-centric equipment, products and systems.

Industrial Automation Systems

Maximizing productivity and efficiency with cutting-edge automation technology.

OVERVIEW

Servo Application Examples	4	1
Product Lines	6	2
Controllers	8	3
Servo Amplifiers	12	4
Servo Motors	22	5
Engineering Software	26	6
Networks	30	7
Controller Selection Guide	34	8
Solutions	42	9
Production System/R&D	44	10
History of Mitsubishi Electric Servo System	48	11
Support	50	12
Warranty	52	13

Related Catalogs

Refer to the following catalogs for details:



Mitsubishi Electric Servo System Controllers
MELSEC iQ-R/MELSEC iQ-F series catalog
L(NA)03100



Mitsubishi Electric General-Purpose AC Servo MELSERVO-J4 catalog
L(NA)03058



MELSEC iQ-R Series iQ Platform-compatible PAC catalog
L(NA)08298ENG



MELSEC iQ-F Series catalog
L(NA)08428ENG



Ethernet-based Open Network CC-Link IE Product Catalog
L(NA)08111E

Servo Application Examples

Industry leading performance MELSERVO supports various system configurations.

Going beyond servo amplifiers and servo motors, Mitsubishi Electric offers system level solutions that include programmable controllers, Motion controllers, and networks to satisfy a broad scope of needs.

Automotive manufacturing



Improve productivity and realize flexibility in different automotive assembly lines with high-accuracy motion control, including linear/circular interpolation and electric cam profile.

Material handling



Realize advanced logistics coordination and eliminate errors in repetitive processes. Servo-based high-speed material handling and highly accurate positioning improve productivity and reduce energy consumption.

Food processing machines



Realize improvements in various packaging applications such as high-speed filling, which requires a highly accurate, continuous feed rate and precision.

Semiconductor manufacturing equipment

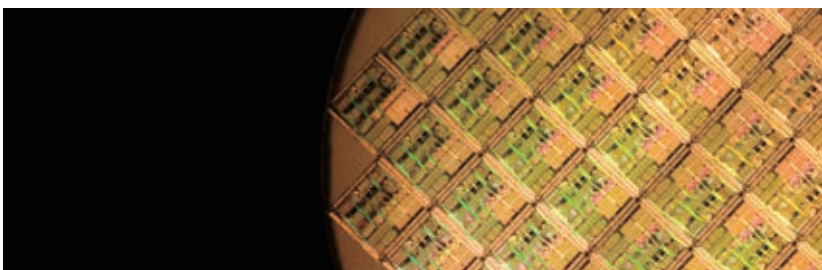

In today's semiconductor manufacturing process, wafer diameter is getting larger and components smaller. To meet the requirements of higher quality and productivity, Mitsubishi Electric's high-performance servos and high-resolution encoder achieve fast and accurate positioning at stable speeds.

Mounters



Flexible mounting of electronic components with high speed and density is demanded in printed circuit board applications. Mitsubishi Electric offers a high level of servo system solutions for rapid mounting of highly miniaturized components and for flexible mounting of irregular shapes.

FPD manufacturing systems



In addition to the high-speed and high-accuracy positioning control, linear servos and a broad array of other actuators play important roles in the manufacturing of constantly evolving flat panel displays.

Printing machines



Mitsubishi Electric provides high-accuracy synchronous system solutions for the paper feeding, printing, cutting, and assembly functions within the printing process, achieving high-speed and high-quality converting applications.

Injection molding machines



The integrated system with the advanced motion control supports high-accuracy molding in injection molding machines, which consist of various control sections.

Machine tools



High-performance servos enable fast and accurate positioning, and support high-speed handling of works. We promote the sophisticated machining capabilities that are a key part of the world's most advanced manufacturing.

Mitsubishi Electric Servo System

Our Total Solution for Your Satisfaction















As the leading supplier of automation products and solutions worldwide, Mitsubishi Electric, known for its high quality and diverse range of automation products including servo system controllers, servo amplifiers, and servo motors, together with our exclusive engineering software and various networks including "CC-Link IE Field Network" and "SSCNET III/H", boasts a whole range of solutions specific to your needs.

2



Product Lines



Controllers

Programmable controller				
 MELSEC IQ-R series	 MELSEC-Q series	 MELSEC-L series	 MELSEC IQ-F series	 MELSEC-F series
Master/local module		Simple Motion module		C controller interface module
CC-Link IE Field Network		SSCNET III/H		SSCNET III/H
 RJ71GF11-T2	 QJ71GF11-T2	 RD77MS	 LD77MS	 Q173SCCF
	 RD77GF	 QD77MS	 FX5-40SSC-S	
		 FX5-80SSC-S		









Interface

CC-Link IE Field Network	CC-Link IE Field Network Basic	SSCNET III/H
		

Servo Amplifiers Sensing Modules

MR-J4-GF	MR-JE-C	MR-J4-B/MR-J4W2-B/MR-J4W3-B		
				
CC-Link IE Field Network compatible servo amplifier MR-J4-GF(-RJ)	Ethernet compatible servo amplifier MR-JE-C	SSCNET III/H compatible servo amplifier MR-J4-B(-RJ)	SSCNET III/H compatible 2-axis servo amplifier MR-J4W2-B	SSCNET III/H compatible 3-axis servo amplifier MR-J4W3-B
	* MR-JE-C also supports the pulse train input.			

Servo Motors

Rotary servo motor for MR-J4					
 Small capacity, low inertia HG-KR series Capacity: 50 to 750 W	 Small capacity, ultra-low inertia HG-MR series Capacity: 50 to 750 W	 Medium capacity, medium inertia HG-SR series Capacity: 0.5 to 7 kW			
 Medium/large capacity, low inertia HG-JR series Capacity: 0.5 to 55 kW	 Ultra-compact, ultra-small capacity HG-AK series Capacity: 10 to 30 W	 Medium capacity, ultra-low inertia HG-RR series Capacity: 1 to 5 kW			
 Medium capacity, flat type HG-UR series Capacity: 0.75 to 5 kW	 Ultra-large capacity, HG-JR series Capacity: 110 to 220 kW	 Available in the future Large capacity, ultra-low inertia HG-RR series Capacity: 11 to 22 kW			

Solution



e-F@ctory is the Mitsubishi Electric solution for improving the performance of any manufacturing enterprise by enhancing productivity, and reducing the maintenance and operation costs together with seamless information flow throughout the plant.

Mitsubishi Electric's integrated FA platform for achieving lateral integration of controllers &HMI, engineering environments and networks at production sites.

Graphic Operation Terminal | **Personal computer**

GOT2000 series

Software

- MELSOFT GX Works3
- MELSOFT MT Works2
- MELSOFT MR Configurator2
- Capacity Selection Software

Low-Voltage Switchgear

Molded-case circuit breaker | Magnetic contactor

WS-V | MS-T

Motion Controller

SSCNET III/H

RnMTCPU | Q17nDSCPU | Q170MSCPU

Personal computer embedded type

SSCNET III/H | CC-Link IE

MR-MC series | MR-EM340GF

Positioning module

Pulse train

RD75P | QD75PN | LD75P | FX3U-1PG
RD75D | QD75DN | LD75D | FX5-20PG-P

SSCNET III/H

Pulse train input/ Positioning function



MR-CV+MR-J4-DU_B(-RJ)

NEW

Power regeneration converter + SSCNET III/H compatible drive unit
MR-CV+MR-J4-DU_B(-RJ)

Sensing module

NEW

SSCNET III/H compatible sensing module
MR-MT2000 series

MR-JE-B

SSCNET III/H compatible servo amplifier
MR-JE-B

MR-J4-A

General-purpose interface compatible servo amplifier
MR-J4-A(-RJ)

MR-JE-A

General-purpose interface compatible servo amplifier
MR-JE-A

* MR-JE-B does not support the Motion controllers.

Linear servo motor for MR-J4

Core type
LM-H3 series
Rating: 70 to 960 N

Core type (natural/liquid cooling)
LM-F series
Rating: 300 to 3000 N (natural cooling)
Rating: 600 to 6000 N (liquid cooling)

Core type with magnetic attraction counter-force
LM-K2 series
Rating: 120 to 2400 N

Coreless type
LM-U2 series
Rating: 50 to 800 N

Direct drive motor for MR-J4

NEW

Low-profile flange type
TM-RG2M series
Rating: 2.2 to 9 N-m

Low-profile table type
TM-RU2M series
Rating: 2.2 to 9 N-m

High rigidity
TM-RFM series
Rating: 2 to 240 N-m

Rotary servo motor for MR-JE

Small capacity, low inertia
HG-KN series
Capacity: 100 to 750 W

Medium capacity, medium inertia
HG-SN series
Capacity: 0.5 to 3 kW

Controllers

From simple positioning to multi-axis and high-speed systems

Our extensive product lines cover from Positioning modules, which enables positioning with simple programs, to Simple Motion modules and Motion controllers, which enable advanced control.

MELSEC iQ-R series



The MELSEC iQ-R series is equipped with the new, high-speed system bus, achieving a shorter cycle time.

Simple Motion module



RD77GF



The RD77GF is a CC-Link IE Field Network compatible Simple Motion module which combines the versatility of Ethernet and highly accurate synchronous operation for Motion control.

The module easily performs various control, such as synchronous, cam, and speed-torque control using only sequence programs.

	RD77GF4	RD77GF8	RD77GF16	RD77GF32
Number of control axes	Up to 4 axes	Up to 8 axes	Up to 16 axes	Up to 32 axes
Operation cycle	0.5 ms or longer			
Servo amplifier	MR-J4-GF(-RJ)			
Command interface	CC-Link IE Field Network			

Simple Motion module



RD77MS



The RD77MS is an intelligent function module which easily performs various control, such as positioning, synchronous, cam, and speed-torque (tightening & press-fit) control using only sequence programs.

	RD77MS2	RD77MS4	RD77MS8	RD77MS16
Number of control axes	Up to 2 axes	Up to 4 axes	Up to 8 axes	Up to 16 axes
Operation cycle	0.444 ms or longer			
Servo amplifier	MR-J4-B(-RJ)/MR-J4W_-B MR-JE-B			
Command interface	SSCNET III/H			

Motion controller



RnMTCPU



The RnMTCPU is a CPU module which performs control using the Motion SFC program, independently of a PLC CPU.

The controller performs various advanced Motion control, such as positioning, speed, torque, tightening & press-fit, synchronous, and cam control.

Add-on libraries can be additionally installed to the Motion controller to expand its functionality. With "G-code control add-on library" (not free of charge), the Motion controller can use G-code programs to control a processing machine using general-purpose AC servo. With an add-on library "machine library" (free of charge), the controller can control a simplified robot (link configuration).

	R16MTCPU	R32MTCPU	R64MTCPU
Number of control axes	Up to 16 axes	Up to 32 axes	Up to 64 axes
Operation cycle	0.222 ms or longer		
Servo amplifier	MR-J4-B(-RJ)/MR-J4W_-B		
Command interface	SSCNET III/H		

Positioning module

RD75P/RD75D



The RD75P/RD75D are capable of controlling up to four axes with a high-speed pulse output (5 Mpulses/s¹ at fastest). The RD75P and the RD75D are compatible with the transistor output and the differential driver output respectively.

*1. This speed is applicable when a differential driver output type is used. The speed depends on the specifications of servo amplifiers.

	RD75P2	RD75P4	RD75D2	RD75D4
Number of control axes	Up to 2 axes	Up to 4 axes	Up to 2 axes	Up to 4 axes
Start time	0.3 ms or longer			
Servo amplifier	MR-J4-A(-RJ) MR-JE-A/MR-JE-C			
Command interface	Pulse train (transistor output)		Pulse train (differential driver output)	

MELSEC-Q series



A variety of MELSEC-Q series controllers fully meets the control needs in each industry and field.

Simple Motion module



QD77GF

The QD77GF is a CC-Link IE Field Network compatible Simple Motion module which combines the versatility of Ethernet and highly accurate synchronous operation for Motion control.

- QD77GF4: 4 axes
- QD77GF8: 8 axes
- QD77GF16: 16 axes



Simple Motion module



QD77MS

The QD77MS is simple to use just like Positioning modules while capable of performing various control, such as positioning, synchronous, cam, and speed-torque control (tightening & press-fit) using only sequence programs.

- QD77MS2: 2 axes
- QD77MS4: 4 axes
- QD77MS16: 16 axes



Motion controller



Q17nDSCPU

The Q17nDSCPU is a CPU module used with a PLC CPU for Motion control.

- Q172DSCPU: 16 axes
- Q173DSCPU: 32 axes



Stand-alone Motion controller



Q170MSCPU

The Q170MSCPU is an all-in-one controller integrating a power supply, a PLC, and a Motion controller.

- Q170MSCPU: 16 axes (Equivalent to Q03UDCPU)
- Q170MSCPU-S1: 16 axes (Equivalent to Q06UDHCPU)



Positioning module

QD75PN/QD75DN

The QD75PN/QD75DN are pulse train output compatible modules. The QD75PN is for transistor output, and the QD75DN is for differential driver output.

- QD75P1N/QD75D1N: 1 axis
- QD75P2N/QD75D2N: 2 axes
- QD75P4N/QD75D4N: 4 axes



Positioning module

QD70P/QD70D

The QD70P/QD70D are pulse train output compatible modules. These modules are suitable for driving stepping motors because they enable smooth acceleration/deceleration with gradual speed change.

- QD70P4/QD70D4: 4 axes
- QD70P8/QD70D8: 8 axes



MELSEC iQ-F series



From stand-alone use to networked system applications, the MELSEC iQ-F series brings your business to the next level of industry.

Simple Motion module



FX5-40SSC-S/FX5-80SSC-S



The FX5-40SSC-S/FX5-80SSC-S are next-generation, compact servo system controllers with extensive built-in functions.

These modules easily perform various control, such as synchronous, cam, and speed-torque control (tightening & press-fit) using only sequence programs.

	FX5-40SSC-S	FX5-80SSC-S
Number of control axes	Up to 4 axes	Up to 8 axes
Servo amplifier	MR-J4-B(-RJ)/MR-J4W_-B MR-JE-B	
Command Interface	SSCNET III/H	

PLC CPU module (built-in positioning function)

FX5U/FX5UC series



The FX5U/FX5UC feature a built-in positioning function with 4-axis pulse output. They can execute positioning by using a positioning instruction and table operation. Together with high-speed pulse I/O modules, control of up to 12 axes is possible.

	FX5U/FX5UC series	
Number of control axes	Up to 4 axes	
Servo amplifier	MR-J4-A(-RJ) MR-JE-C MR-JE-A	MR-J4-GF(-RJ) MR-JE-C
Command Interface	Pulse train (transistor output)	CC-Link IE Field Network Basic

MELSEC-L series



The MELSEC-L series is a baseless highly scalable controller ideal for applications having limited space.

Simple Motion module



LD77MS

The LD77MS is simple to use just like Positioning modules while capable of performing various control, such as positioning, synchronous, cam, and speed-torque (tightening & press-fit) control.

- LD77MS2: 2 axes
- LD77MS4: 4 axes
- LD77MS16: 16 axes



SSCNET III/H Head module



LJ72MS15

The SSCNET III/H head module is used to connect the MELSEC-L series I/O module and the intelligent function module to SSCNET III/H.



Positioning module

LD75P/LD75D

The LD75P/LD75D are pulse train output compatible modules. The LD75P is for transistor output, and the LD75D is for differential driver output.

- LD75P1/LD75D1: 1 axis
- LD75P2/LD75D2: 2 axes
- LD75P4/LD75D4: 4 axes



PLC CPU module (built-in positioning function)

LCPU

The positioning function, equipped as standard, outputs command pulses to a servo amplifier by using the built-in I/O function.

Control axes: 2 axes



MELSEC-F series

MELSEC-F

Main unit (built-in positioning function)

FX3U/FX3UC

The FX3U and FX3UC feature positioning functionality with pulse outputs, enabling positioning control only with the main unit.

FX3U and FX3UC: 3 axes



FX3U

Positioning module

FX3U-1PG

This pulse train output block is used with the FX series programmable controller.

FX3U-1PG: 1 axis



FX3U-1PG

Ethernet-based open network CC-Link IE master stations

Servo control is enabled by the Ethernet-based open network CC-Link IE compatible master station. The following are examples of master stations.

Master/local module

CC-Link IE Field

RJ71GF11-T2/QJ71GF11-T2

The RJ71GF11-T2/QJ71GF11-T2 are master/local modules supporting CC-Link IE Field Network. With these modules, MR-J4-GF(-RJ) can be used in I/O mode for positioning control.

RnENCPU and L series master/local module can also be used as a master station.



RJ71GF11-T2

CPU module

CC-Link IE Field Basic

FX5U/FX5UC/RnCPU/RnENCPU

The FX5U/FX5UC/RnCPU/RnENCPU are PLC CPU modules supporting CC-Link IE Field Network Basic.

Having a built-in Ethernet port, these CPU modules can be used as a master station.

The equivalent CPU modules are also available in Q and L series.



FX5U

C Controller/Personal computer embedded type servo system controllers

A combination of the board controllers and a personal computer, or the interface module and a C controller enables high-response servo control.

Simple Motion board

CC-Link IE Field

MR-EM340GF

Embedded in a personal computer, the MR-EM340GF Simple Motion board controls MR-J4-GF through a user program.

The controller supports PCI Express®.

Control axes in motion mode: 16 axes

Control stations in I/O mode: 120 stations

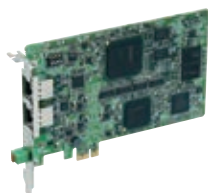

Position Board

SSCNET III/H

MR-MC series

Embedded in a personal computer, the MR-MC series Position Boards control MR-J4-B through a user program.

The controllers support PCI Express®, PCI bus, and Compact PCI®.

MR-MC2_0: 20 axes

MR-MC2_1: 32 axes

MR-MC341: 64 axes



C Controller Interface Module

SSCNET III/H

Q173SCCF

Connected directly to a C Controller via PCI Express®, the Q173SCCF controls MR-J4-B through a user program.

Q173SCCF: 20 axes



Servo Amplifiers

From the industry's top level high-speed, high-accuracy servos to one-touch servos and multi-axis models. In addition to the high-end MELSERVO-J4 series, a variety of models to match various applications is available. The Mitsubishi Electric's servo amplifiers support motors from rotary servo motors to linear servo motors and direct drive motors, and greatly enhance system performance.

~Man, Machine and Environment in Perfect Harmony~

MELSERVO-J4 series

MELSERVO-J4 series is the leading member of the MELSERVO family, backed by Mitsubishi Electric's leadership in all-digital technology. With safety, Ethernet-based CC-Link IE Field Network, SSCNET III/H high-speed optical communication and energy-efficient design of the MELSERVO-J4 series - man, machine and environment can at last work together in perfect harmony.

MR-J4-GF(-RJ)
CC-Link IE Field Network compatible servo amplifier



This servo amplifier is compatible with CC-Link IE Field Network. Together with the Simple Motion module, advanced synchronous control and interpolation control by sequential commands are enabled. The servo amplifier has a built-in point table function (point table method/indexer method), offering easy positioning with a combination with a master module. The servo amplifier also supports CC-Link IE Field Network Basic.

Command interface	CC-Link IE Field Network		
Control mode	Position/Speed/Torque/Fully closed loop		
Power supply	100 V AC	200 V AC	400 V AC
Capacity range	0.1 kW to 0.4 kW	0.1 kW to 22 kW	0.6 kW to 22 kW
Compatible servo motor	Rotary servo motor, linear servo motor, DD motor		

MR-J4-B(-RJ)
MR-J4W2-B/MR-J4W3-B
SSCNET III/H compatible servo amplifier



A complete synchronous system with SSCNET III/H can be configured using 0.222 ms cycle high-speed serial communication between the controller and the servo amplifier. 2-axis/3-axis servo amplifiers are also available, enabling energy-saving, less-wiring, compact machine at lower cost.

Command interface	SSCNET III/H		
Control mode	Position/Speed/Torque/Fully closed loop		
Power supply	100 V AC	200 V AC	400 V AC
Capacity range	0.1 kW to 0.4 kW	0.1 kW to 37 kW	0.6 kW to 55 kW
Compatible servo motor	Rotary servo motor, linear servo motor, DD motor		

MR-J4-A(-RJ)
General-purpose interface compatible servo amplifier



Pulse train and analog input, etc., are provided as a standard for the command interface. Position, speed, and torque control modes are available, and the modes can be switched with an input device. The MR-J4-A-RJ has a built-in positioning function, supporting MODBUS® RTU, simple cam, and mark sensor input compensation.

Command interface	Pulse train/Analog voltage/RS-422/MODBUS® RTU		
Control mode	Position/Speed/Torque/Fully closed loop		
Power supply	100 V AC	200 V AC	400 V AC
Capacity range	0.1 kW to 0.4 kW	0.1 kW to 37 kW	0.6 kW to 55 kW
Compatible servo motor	Rotary servo motor, linear servo motor, DD motor		

MR-J4W2-0303B6
MR-J4-03A6(-RJ)
Ultra-small capacity servo amplifier



This servo amplifier is compatible with the ultra-compact HG-AK servo motor series (10 W to 30 W) and two types of main circuit power supply of 48 V DC and 24 V DC, being suitable for compact machines. 2-axis servo amplifiers are also available.

Command interface	SSCNET III/H or Pulse train/Analog voltage/RS-422		
Control mode	Position/Speed/Torque		
Power supply	48 V DC/24 V DC		
Capacity range	10 W to 30 W		
Compatible servo motor	Rotary servo motor		

Harmony with Machine

The leading edge in drive control, with unrivaled accuracy and response for next-generation machine performance.

Industry-Leading Level of Servo Amplifier Basic Performance

Speed frequency response of 2.5 kHz is achieved by applying our original high-speed servo control architecture evolved from the conventional two-degrees-of-freedom model adaptive control to the dedicated execution engine. Together with a high-resolution absolute position encoder of 4,194,304 pulses/rev, fast and accurate operation is enabled. The performance of the high-end machines is utilized to the fullest.

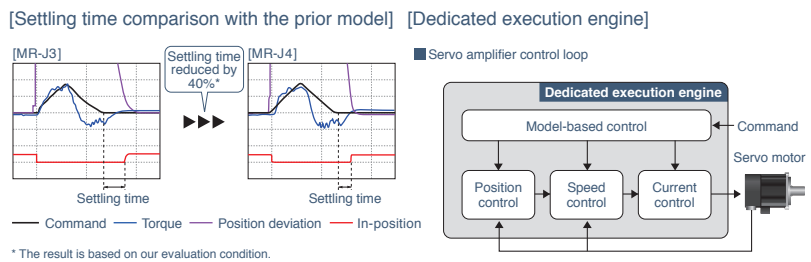

One-Touch Tuning

Just turn on the one-touch tuning function to complete servo gain adjustment automatically, including machine resonance suppression filter, advanced vibration suppression control II¹, and robust filter for maximizing your machine performance. This function also sets responsivity automatically, while the real-time auto tuning requires manual setting. Moreover, a new method² allows to create an optimum tuning command inside the servo amplifier.

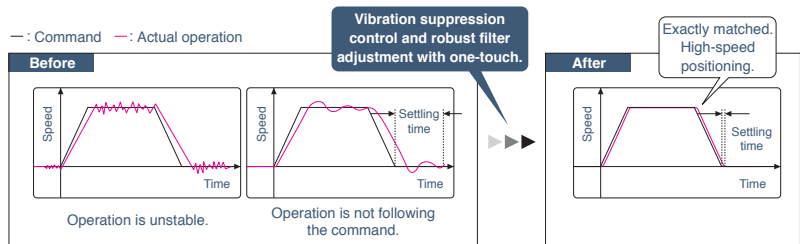

*1. The advanced vibration suppression control II automatically adjusts one frequency.
*2. This new method is supported by MR-J4-B/MR-J4W_-B/MR-J4-A.

Advanced Vibration Suppression Control II

The advanced vibration suppression control II suppresses two types of low-frequency vibrations, owing to vibration suppression algorithm which supports three-inertia system. This function is effective in suppressing residual vibration with relatively low frequency of approximately 100 Hz or less generated at the end of an arm and in a machine, enabling a shorter settling time.

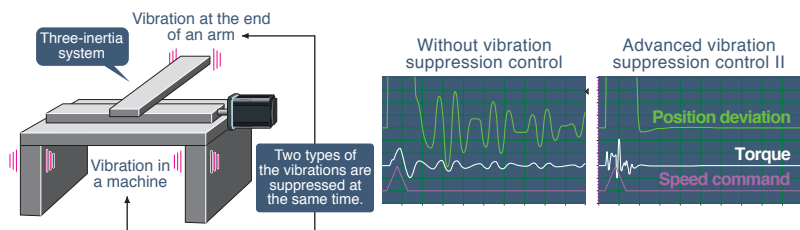

Application examples

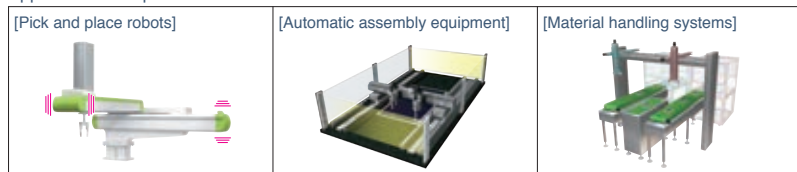

Robust Filter

Achieving both high responsivity and stability was difficult with the conventional control in high-inertia systems with belts and gears such as printing and packaging machines. Now, this function enables the high responsivity and the stability at the same time without adjustment. The robust filter gradually reduces the fluctuation of torque in a wide frequency range and achieves more stability as compared to the prior model.

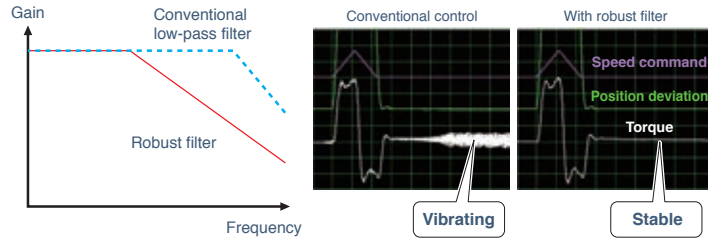

Application examples

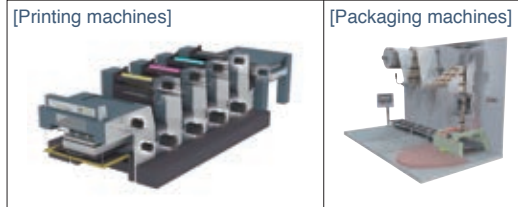

Expanded Machine Resonance Suppression Filter

With advanced filter structure, applicable frequency range is expanded from between 100 Hz and 4500 Hz to between 10 Hz and 4500 Hz. Additionally, the number of simultaneously applicable filters is increased from two to five, improving vibration suppression performance of a machine.

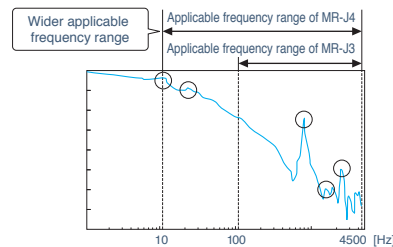

Lost Motion Compensation Function

This function suppresses quadrant protrusion caused by friction and torsion generated when the servo motor rotates in a reverse direction. Therefore, the accuracy of circular path will be improved in trajectory control used in XY table, etc.

* This function is not supported by MR-J4W2-B and MR-J4W3-B.

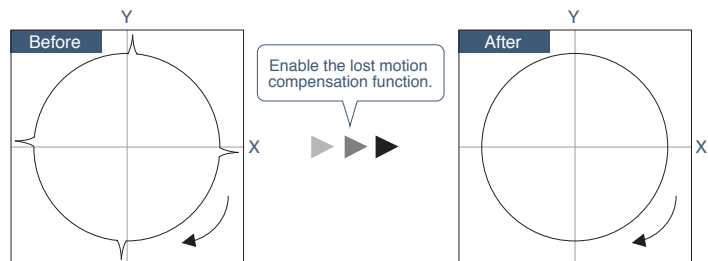

Suppression of quadrant protrusion of circular trajectory

Built-in Positioning Function

MR-J4-GF(-RJ) and MR-J4-A-RJ have a built-in positioning function, enabling positioning operation with point table, program-based*, and indexer methods. With these servo amplifiers, a positioning system is configured without a Positioning module (command pulse). Positioning command is executed by CC-Link IE Field network, input/output signals, or RS-422/RS-485 communication (up to 32 axes). MR Configurator2 allows easy setting of the positioning data.

* The program-based method is supported only by MR-J4-A-RJ.

Point table method* GF GF-RJ A-RJ

Set position data (target position), servo motor speed, and acceleration/deceleration time constants in point table. Up to 255 points can be set in the point table, and setting the data is as easy as setting parameters. Perform positioning operation with a start signal after selecting the point table Nos.

* For MR-J4-A-RJ, point table can be set with push buttons on the servo amplifier or with MR-PRU03 parameter unit.

Point table example

Point table No.	Position data	Servo motor speed	Acceleration time constant	Deceleration time constant	Dwell	Sub function	M code
1	1000	2000	200	200	0	1	1
2	2000	1600	100	100	0	0	2
⋮	⋮	⋮	⋮	⋮	⋮	⋮	⋮
255	3000	3000	100	100	0	2	99

Operation

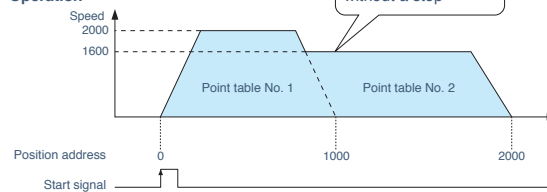

Program method* A-RJ

Create positioning programs with dedicated commands, and perform positioning operation with a start signal after selecting the program Nos. The program-based method enables more complex positioning operation than the point table method. Maximum of 256 programs are settable. (The total number of steps of all programs: 640)

* MR Configurator2 is required to create programs.

Program example

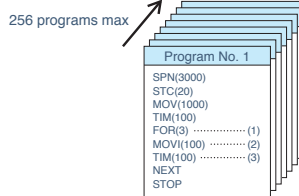

Operation

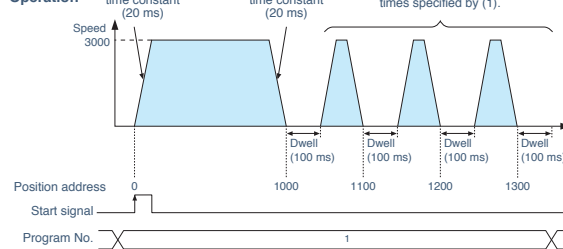

Indexer method* GF GF-RJ A-RJ

Perform positioning operation by specifying equally divided stations (up to 255 stations) and the number of gear teeth on machine and motor sides. The travel distance will be calculated automatically based on the number of equally divided stations set in the parameter. The positioning operation is performed with a start signal after the station position No. is selected. Rotation direction specifying indexer or shortest rotating indexer can be set.

* Fully closed loop control mode and linear servo motor control mode are not supported by the indexer method.

MR-J4-GF
MR-J4-A-RJ

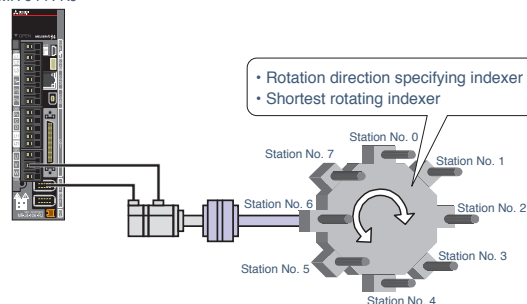

Harmony with Man

The leading edge in safety and convenience, designed to harmonize with the way you work.

Functions Compliant with IEC/EN 61800-5-2

STO (Safe torque off) and SS1^{*1} (Safe stop 1) are integrated as standard, enabling the safety system to be configured easily in a machine.

- By using STO, it is not necessary to turn off the control power of the servo amplifier, resulting in a shorter restart time and eliminating the necessity of home position return.
- A magnetic contactor for preventing unexpected motor start is not needed.^{*2}
- The safety level of STO is increased to SIL 3 from SIL 2.^{*3}

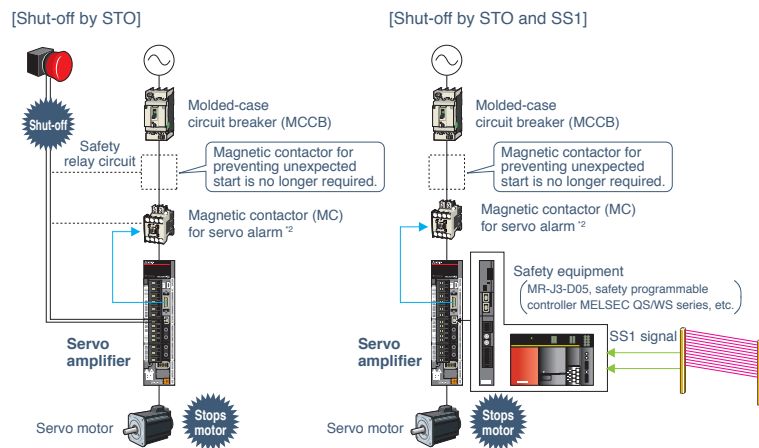

IEC/EN 61800-5-2:2007 function	Safety level
STO (Safe torque off)	Category 3 PL e, SIL 3 ^{*3}
SS1 (Safe stop 1) ^{*1}	

*1. Safety equipment (MR-J3-D05, safety programmable controller MELSEC QS/WS series, etc.) is required.

*2. For MR-J4 series servo amplifier, magnetic contactors are not required to meet the STO requirements. However, this illustration has a magnetic contactor installed to prevent servo alarms and electric shock.

*3. For Category 3 PL e, SIL 3, use compatible safety equipment and set the parameters. When MR-J3-D05 is used, safety level is Category 3 PL d, SIL 2.

Category 4 PL e, SIL 3 with functional safety unit

Safety level is Category 4 PL e, SIL 3 when the safety signals are inputted directly to MR-D30 functional safety unit or through safety communication to the servo amplifier. The safety observation function is operated on the MR-D30, and therefore expansion of the safety observation function is possible independent of controllers.

Servo motors with functional safety are now available. (HG-KR_W0C/HG-SR_W0C/HG-JR_W0C)

IEC/EN 61800-5-2:2007 function	Safety level
STO (Safe torque off)	Category 4 PL e, SIL 3
SS1 (Safe stop 1)	
SS2 (Safe stop 2) ^{*1}	
SOS (Safe operating stop) ^{*1}	
SLS (Safely-limited speed) ^{*2}	
SBC (Safe brake control)	
SSM (Safe speed monitor) ^{*2}	

*1. Requires the use of a servo motor with functional safety.

*2. Safety level is Category 3 PL d, SIL 2 when the servo motor with functional safety is not used.

By wiring to MR-D30 functional safety unit

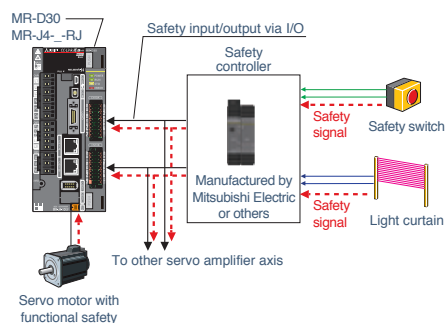

By CC-Link IE Field Network safety communication

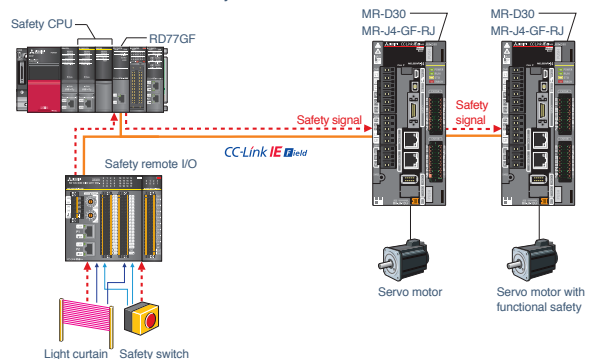

Tough Drive Function

Instantaneous power failure tough drive

When an instantaneous power failure is detected, this function allows the servo amplifier to use the electric energy charged in the main circuit capacitor in the servo amplifier to avoid an alarm occurrence, increasing the machine availability even with an unstable power supply.

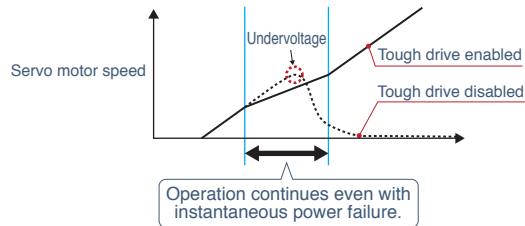

Vibration tough drive

Machine resonance suppression filter is automatically readjusted when a change in machine resonance frequency is detected by the servo amplifier, reducing unplanned machine downtime caused by age-related degradation.

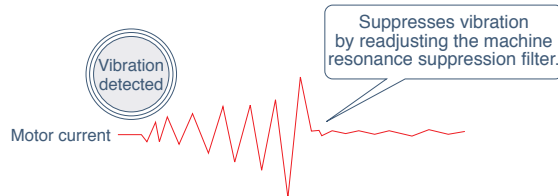

Large Capacity Drive Recorder

Servo data such as motor current and position command before and after the alarm occurrence are stored in non-volatile memory of the servo amplifier. Reading the servo data on MR Configurator2 helps you analyze the cause of the alarm.

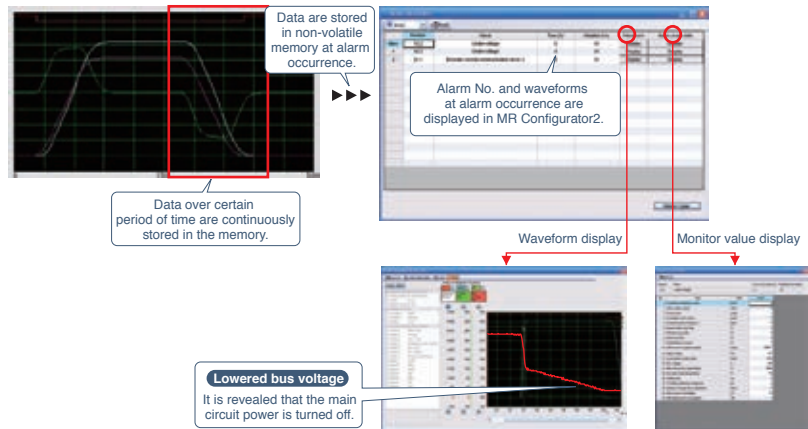

Machine Diagnosis Function

This function detects changes in mechanical parts (ball screw, guide, bearing, belt, etc.) by analyzing changes in machine friction, load moment of inertia, unbalanced torque, and vibration components from the data inside a servo amplifier, supporting timely maintenance of these parts. The following failure prediction functions are available with MR-J4-GF and notify the maintenance timing.

- Friction failure prediction function
- Vibration failure prediction function
- Total distance failure prediction function

[Machine diagnosis function window on MR Configurator2]

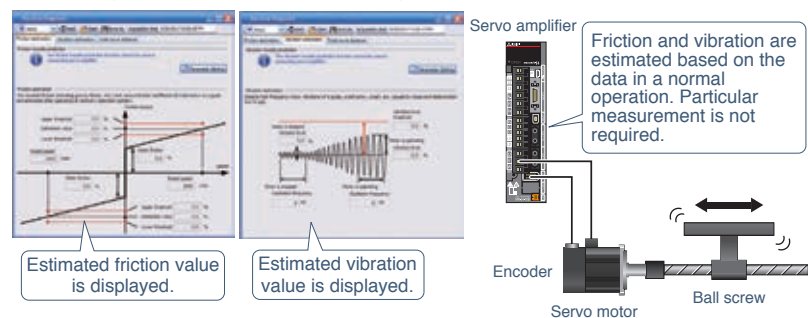

Harmony with the Environment

An evolution in eco-friendly design, and that's winning acclaim worldwide.

2-axis/3-axis Types for Energy-Saving, Miniaturized, and Low-Cost Machine

2-axis and 3-axis servo amplifiers are available for operating two and three servo motors, respectively. These servo amplifiers enable energy-saving, compact machine at lower cost. Different types of servo motors including rotary servo motors, linear servo motors, and direct drive motors are freely combined as long as the servo motors are compatible with the servo amplifier.

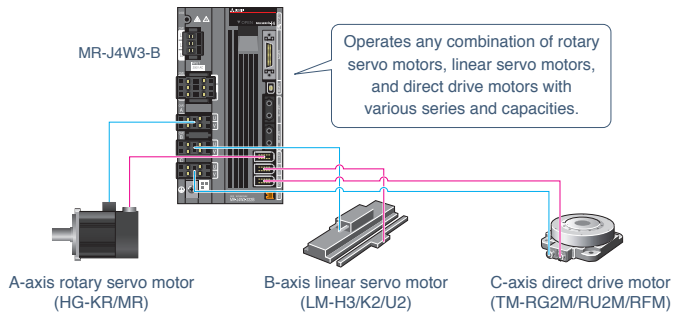

Space-Saving with Industry's Smallest* 3-axis Type

2-axis servo amplifier MR-J4W2-B requires 26% less installation space than two units of MR-J4-B. 3-axis servo amplifier MR-J4W3-B requires 30% less installation space than three units of MR-J4-B.

[Example of installation space for two units of each 100 W, 200 W, 400 W, and 750 W]

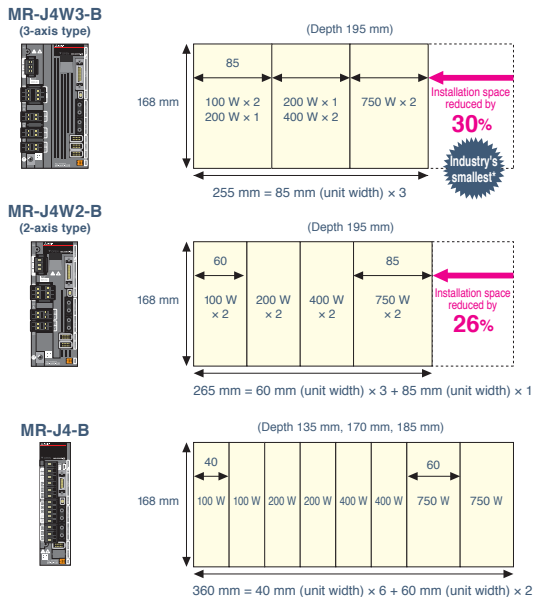

* Based on Mitsubishi Electric research as of August 2018

Reduced Wiring by Approx. 50% with 3-axis Type

The three axes of 3-axis servo amplifier MR-J4W3-B use the same connections for main and control circuit power, peripheral equipment, control signal wire, etc. Thus, the number of wirings and devices is greatly reduced.

[Comparison of the number of wirings]

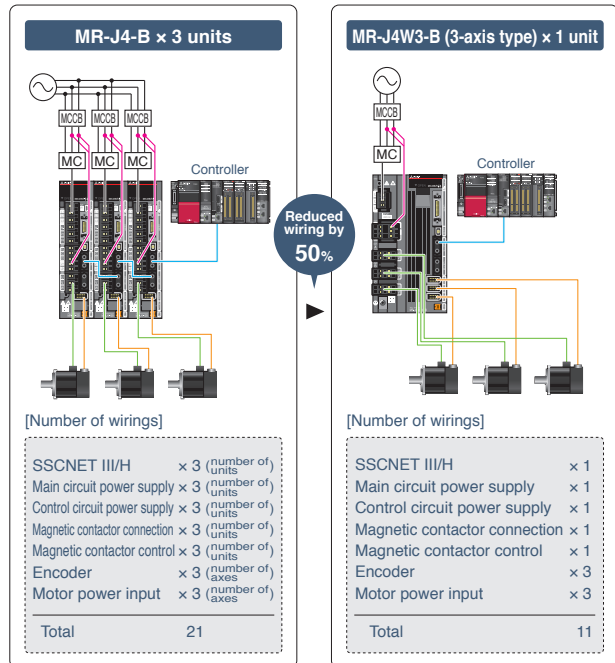

Energy-Conservation with Common DC Bus Connection

When multiple servo amplifiers and drive units are connected to the MR-CV power regeneration converter unit by a common DC bus connection, the regenerative energy of one axis is used for driving other axes, contributing to energy-conservation. The multi-axis servo amplifier has the same effect.

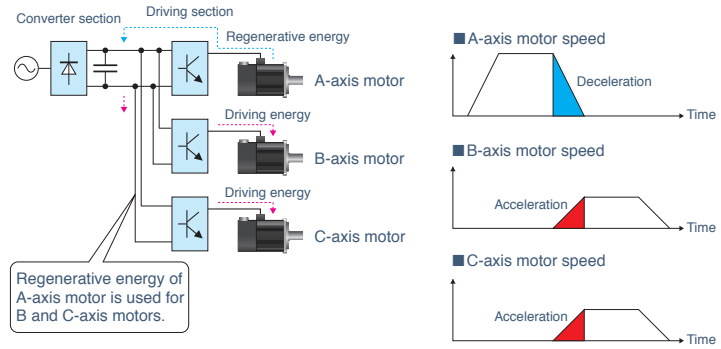

Further Energy-Conservation with Power Regeneration System

The MR-CV power regeneration converter unit has a power regeneration system which returns the regenerative energy back to the power supply, enabling the regenerative energy to be used for other systems for further energy-conservation. In addition, when the MR-CV power regeneration converter unit is used, a regenerative option is not required, and thus, the total heat generation in a system will be decreased.

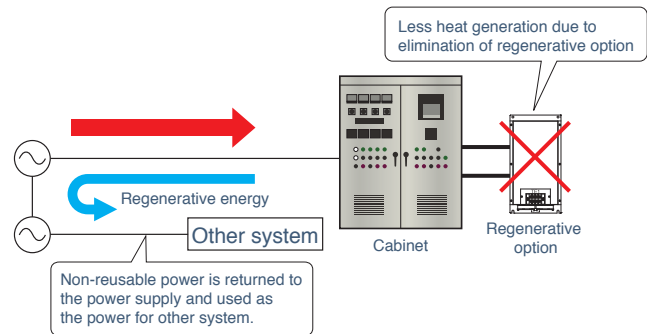

System Configuration Examples

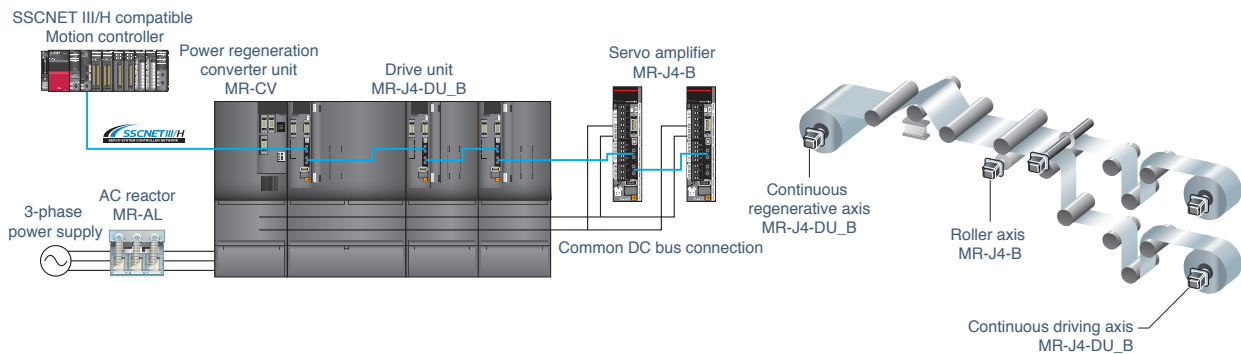

Heritage

A heritage of trust and continuity — the hallmark of every MELSERVO product.

Easy Replacement of MR-J3 Series

MR-J4-B/MR-J4-A has the same mounting dimensions^{*1} with MR-J3-B/MR-J3-A. HG rotary servo motor series has the same mounting dimensions^{*2} and uses the same option cables for the power, the encoder^{*3}, and the electromagnetic brake as HF series or HC-RP/HC-UP series.

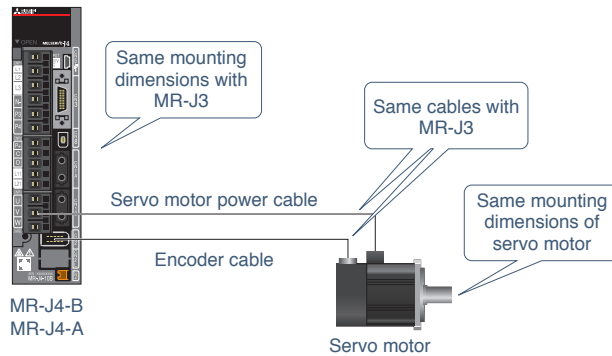

*1. Mounting dimensions are smaller for servo amplifiers rated 200 V 5 kW, 400 V 3.5 kW, 200 V/400 V 11 kW, and 200 V/400 V 15 kW.
 *2. For replacing HA-LP series with HG-JR series, contact your local sales office for more detail.
 *3. HG-JR series of 11 kW to 55 kW uses a different encoder cable from HF-JP series.

Supporting Replacement of MR-J2-Super Series

MELSERVO-J4 series product lines include general-purpose interface, positioning function, and SSCNET III/H interface. MELSERVO-J4 series is compatible with a wide variety of command interface and also replaceable from MELSERVO-J2S series.

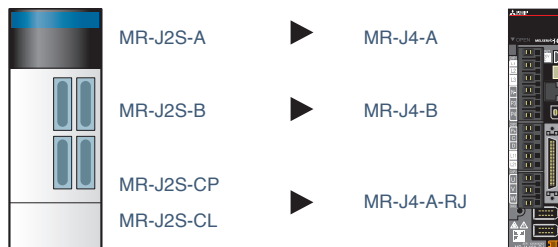

We provide support for the renewal with the following materials from the catalog of renewal introduction, the handbook with detailed information to the instruction manual for the renewal tool to use the existing wiring.



Transition from MELSERVO-J3/J3W Series to J4 Series Handbook L(NA)03127

This handbook explains how to replace your MR-J3/J3W with MR-J4 series.



Transition from MELSERVO-J2-Super/J2M Series to J4 Series Handbook L(NA)03093

This handbook explains how to replace your MR-J2S/J2M with MR-J4 series.



MR-J2S Renewal Tool Catalog X901307-312

This guide introduces a renewal tool for replacing MR-J2S with MR-J4. The renewal tool allows to use the existing wiring and mounting holes, making the replacement simple and fast.

Mitsubishi Electric System & Service Co., Ltd.

~Reliable Basic Performance and Advanced Ease-of-Use~

MELSERVO-JE series

[Easy To Use]

- One-touch tuning adjusts servo gains with one-touch ease.
- Instantaneous power failure tough drive function and a large capacity capacitor reduce machine downtime.
- MR-JE-C and MR-JE-B support absolute position detection system.
- MR-JE-C and MR-JE-A have a built-in positioning function. MR-JE-A is equipped with advanced functions such as simple cam and position compensation.

[High Performance]

- MR-JE series is compatible with various networks including CC-Link IE Field Network Basic, SSCNET III/H, and MODBUS®.
- The dedicated engine enables speed frequency response of 2.0 kHz, shortening the cycle time.
- The large capacity main circuit capacitor allows the regenerative energy to be used effectively.

[Global Standard]

- Global servo, MR-JE series, complies with global standards as standard.
- Command pulse input and digital input/output are compatible with both sink and source type connections.

MR-JE-C
Ethernet compatible servo amplifier



MR-JE-C supports Ethernet communication (CC-Link IE Field Network Basic, SLMP, and MODBUS®/TCP) and RS-485 communication (MODBUS® RTU), and enables a flexible system configuration. In addition, the MR-JE-C has a built-in positioning function (point table method and indexer method), making positioning operation easy without a Positioning module.

Command interface	CC-Link IE Field Network Basic, SLMP, and MODBUS®/TCP, MODBUS® RTU
Control mode	Position/Speed/Torque
Power supply	200 V AC
Capacity range	0.1 kW to 3 kW
Compatible servo motor	Rotary servo motor

MR-JE-B
SSCNET III/H compatible servo amplifier



MR-JE-B is compatible with SSCNET III/H, optical servo system controller network that enables a high-response and multi-axis system with high synchronous performance and less wiring. In addition, absolute position detection system can be configured easily with the MR-JE-B servo amplifiers.

Command interface	SSCNET III/H
Control mode	Position/Speed/Torque
Power supply	200 V AC
Capacity range	0.1 kW to 3 kW
Compatible servo motor	Rotary servo motor

MR-JE-A
General-purpose interface compatible servo amplifier



Pulse train and analog input, etc., are provided as a standard for the command interface. Position, speed, and torque control modes are available, and the modes can be switched with an input device. The MR-JE-A has a built-in positioning function, being compatible with MODBUS®, simple cam, and mark sensor input compensation.

Command interface	Pulse train/Analog/RS-422/MODBUS® RTU
Control mode	Position/Speed/Torque
Power supply	200 V AC
Capacity range	0.1 kW to 3 kW
Compatible servo motor	Rotary servo motor

Servo Motors

From rotary to linear and direct drive motors

Rotary servo motors are available in capacities from 10 W to 220 kW.

Linear servo motors and direct drive motors satisfy new needs in driving control by providing high rigidity, performance and flexibility in system configurations unique to a direct drive.

Rotary servo motor: A wide range of capacities and series for various system applications

HG series for MELSERVO-J4 series

HG-KR/HG-MR



HG-KR: Small capacity, low inertia. Perfect for general-purpose industrial machines.

HG-MR: Small capacity, ultra-low inertia. Perfect for high-throughput operations.

Capacity: 50 W to 750 W

Rated speed: 3000 r/min, Maximum speed: 6000 r/min

[Application example]

- Inserters, mounters and bonders ●PCB drilling machines
- In-circuit testers and label printers ●Knitting and embroidery machines
- Compact robots and robot hand sections

HG-SR



Medium capacity, medium inertia. Suitable for machines having large load inertia.

Capacity: 0.5 kW to 7 kW

Rated speed: 1000 r/min and 2000 r/min

[Application example]

- Material handling systems ●Dedicated machines ●Robots
- Loaders and unloaders ●Winders and tension units ●Turrets ●X-Y tables

HG-JR



Medium to ultra-large capacity, low inertia. Perfect for high-throughput positioning or high acceleration/deceleration operations.

Capacity: 0.5 kW to 220 kW

Rated speed: 1000 r/min, 1500 r/min, 2000 r/min, and 3000 r/min

[Application example]

- Food packaging machines ●Printers ●Injection molding machines ●Press machines

HG-AK



Ultra-compact, ultra-small capacity with flange size of 25 mm. Suitable for small machines.

Capacity: 10 W to 30 W

Rated speed: 3000 r/min, Maximum speed: 6000 r/min

[Application example]

- Mounters and bonders ●Semiconductor/FPD manufacturing systems ●Compact robots
- Electronic component manufacturing machines ●Compact X-Y table

HG-RR



Medium capacity, ultra-low inertia. Perfect for high-throughput operation.

Capacity: 1 kW to 22 kW*

Rated speed: 1500 r/min and 3000 r/min

[Application example]

- Roll feeders ●Loaders and unloaders
- Ultra high-throughput material handling systems ●Vibration testing machines

* HG-RR series with 11 kW, 15 kW, and 22 kW will be available in the future.

HG-UR



Medium capacity, flat type. Perfect for applications with limited mounting space.

Capacity: 0.75 kW to 5 kW

Rated speed: 2000 r/min

[Application example]

- Robots ●Conveyors ●Winders and tension machines
- Food processing machines

Equipped with High-Resolution Absolute Position Encoder

Servo motors are equipped with a high-resolution absolute position encoder of 4,194,304 pulses/rev (22-bit) as standard. Positioning accuracy is increased.

* 262,144 pulses/rev (18-bit) for HG-AK series.

Improved Environmental Resistance

Ingress protection² of servo motors:
 HG-KR/HG-MR/HG-RR/HG-UR: IP65
 HG-SR/HG-JR: IP67¹
 HG-AK: IP55

*1. HG-JR1000 r/min series 15 kW or larger, HG-JR1500 r/min series 22 kW or larger, and HG-JR 2000 r/min series are rated IP44.

*2. The shaft-through portion is excluded.

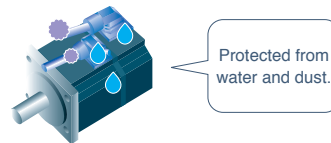

Cable Leading Direction

Cables for power, encoder, and electromagnetic brake are capable of connecting either in direction or in opposite direction of the load side, depending on the cable selection. (HG-KR and HG-MR series)

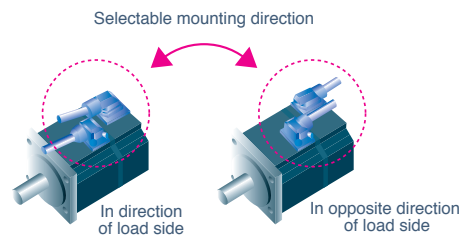

Reduced Torque Ripple during Conduction

The torque ripple is reduced owing to the optimized combination of the numbers of the motor poles and the slots. Thereby, smooth rotation is achieved even during a low-speed operation which is more likely affected by the torque ripple, improving the operation stability.

Torque ripple

[Prior model (HF-KP series)]

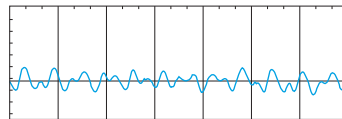

As compared to the prior series.



[New model (HG-KR series)]

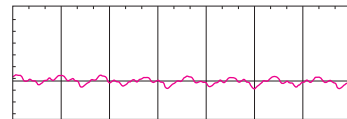

* For 400 W

HG series for MELSERVO-JE series

HG-KN



Small capacity, low inertia. Perfect for general-purpose industrial machines.

Capacity: 0.1 kW to 0.75 kW

Rated speed: 3000 r/min

[Application example]

- Inserters, mounters and bonders ●PCB drilling machines
- In-circuit testers and label printers ●Knitting and embroidery machines
- Compact robots and robot hand sections

HG-SN



Medium capacity, medium inertia. Suitable for machines having large load inertia.

Capacity: 0.5 kW to 3 kW

Rated speed: 2000 r/min

[Application example]

- Material handling systems ●Dedicated machines ●Robots
- Loaders and unloaders ●Winders, tension units ●Turrets ●X-Y tables

Servo Motors

Linear servo motor: Suitable for linear motion systems requiring high speed and accuracy

LM series for MELSERVO-J4 series

LM-H3



Maximum speed: 3 m/s
Rated thrust: 70 N to 960 N
Core type suitable for space-saving.
The magnetic attraction force contributes to high rigidity.

LM-F



Maximum speed: 2 m/s
Rated thrust: 300 N to 3000 N (natural cooling), 600 N to 6000 N (liquid cooling)
Core type compact linear servo motor.
The integrated liquid-cooling system doubles the continuous thrust.
The magnetic attraction force contributes to high rigidity.

LM-K2



Maximum speed: 2 m/s
Rated thrust: 120 N to 2400 N
Core type with magnetic attraction counter-force.
The magnetic attraction counter-force structure extends life of the linear guides and contributes to lowering audible noise.

LM-U2



Maximum speed: 2 m/s
Rated thrust: 50 N to 800 N
Coreless type without cogging resulting in small speed fluctuation.
The structure with no magnetic attraction force extends life of the linear guides.

5

Servo Motors

Sophisticated Performance

Supporting maximum speed of 3 m/s (LM-H3 series) and maximum thrust of 150 N to 18000 N.

Small size and high thrust are achieved by the increased winding density and the optimized core and magnet geometries as a result of electromagnetic field analysis.

Diverse product lines include core, liquid-cooling core, magnetic attraction counter-force core, and coreless types.

A/B/Z-phase differential output type linear encoders are also supported by MR-J4-GF-RJ/MR-J4-B-RJ/MR-J4-A-RJ servo amplifiers.

An advanced system including high-accuracy tandem synchronous control can be configured with CC-Link IE Field Network or SSCNET III/H compatible controller.

[Application example]

Tandem configuration

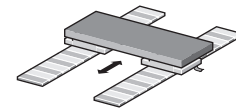

Multi-head configuration

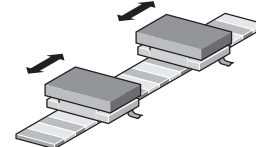

Application Example

[Machine tools XYZ stage]

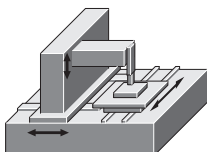

[Semiconductor/FPD manufacturing systems]

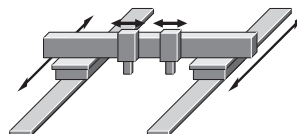

[Screen printing systems]

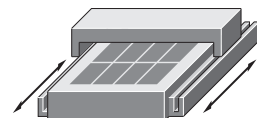

Direct drive motor: For compact and simplified machine driving part with high-accuracy control

TM series for MELSERVO-J4 series

TM-RG2M
TM-RU2M

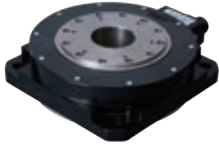

Motor outer diameter: $\phi 130$ mm, $\phi 180$ mm, and $\phi 230$ mm
 Rated torque: 2.2 N·m to 9 N·m
 Low-profile direct drive motor available in two types: flange type (with pilot) and table type (with positioning pin holes)

TM-RFM



Motor outer diameter: $\phi 130$ mm, $\phi 180$ mm, $\phi 230$ mm, $\phi 330$ mm
 Rated torque: 2 N·m to 240 N·m
 High-rigidity direct drive motor for high-torque

Sophisticated Performance

[High performance with the latest technologies]

Our latest magnetic design and winding technologies enable high torque density. In addition, extremely smooth rotation is achieved by the minimized torque ripple.

[Compact and low-profile design]

Due to high level of structural design technology, compact and low-profile design is achieved. This design enables a small mounting space and a low center of gravity.

[High-resolution absolute position encoder]

The direct drive motor is equipped with a high-resolution absolute position encoder (1,048,576 to 4,194,304 pulses/rev) as standard. High-accuracy machine is achieved.

[Hollow shaft diameter range: $\phi 20$ mm to 104 mm]

The motor is equipped with a large hollow shaft resulting from using bearing and encoder with large diameter. It allows cables and air tubing to pass through.

Application Example

Suitable for low speed and high torque applications.

[Coating and vapor deposition systems]

[Spin-type cleaning systems for FPD/semiconductor]

[FPD/semiconductor testing systems (XY θ tables)]

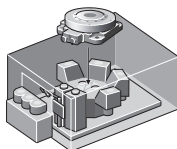

[Index table for machine tools]



[Rotary axis for polishing systems]

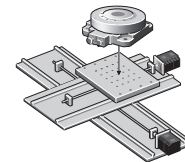

[Rotary axis for material handling robots]

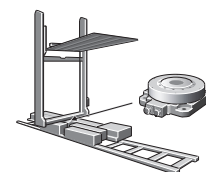
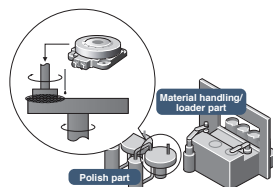
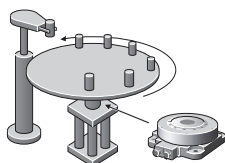

Engineering Software



FA Integrated Engineering Software MELSOFT iQ Works

MELSOFT iQ Works is an integrated software suite consisting of GX Works3, MT Works2, GT Works3, RT ToolBox3, FR Configurator2, MR Configurator2 and CW Configurator, which are programming software for each respective product. Integration is further enhanced with MELSOFT Navigator as the central system configuration incorporating an easy-to-use, graphical user interface with additional project-sharing features such as system labels and parameters. The advantages of this powerful integrated software suite are that system design is made much easier with a substantial reduction in repetitious tasks, cutting down on errors while helping to reduce the overall TCO.



System management software MELSOFT Navigator

System level graphic-based configuration tool that simplifies the system design by providing a visual representation of the system. System management features such as system-wide parameterization, labels and block reading of project data are also included.

Programmable controller engineering software MELSOFT GX Works3

GX Works3 is the latest generation of programming and maintenance software offered by Mitsubishi Electric specifically designed for the MELSEC iQ-R series control system. It includes many new features such as graphic-based system configuration, integrated motion control setup, multiple language support, providing an intuitive engineering environment solution.

HMI/GOT screen design software MELSOFT GT Works3

This graphic operation terminal (GOT) screen creation software is designed with three main features—simplicity, graphics design and operation ease—that help to create graphic screens in fewer steps.

Motion controller engineering software MELSOFT MT Works2

This motion control design and maintenance software includes intuitive graphic-based programming together with a digital oscilloscope simulator.

Servo setup software MELSOFT MR Configurator2

Tuning, monitor display, diagnosis, reading/writing parameters, and test operations are easily performed on a personal computer. This powerful software tool supports a stable machine system and optimum control, and moreover, shortens setup time.

Robot engineering software MELSOFT RT ToolBox3

Inverter setup software MELSOFT FR Configurator2

C Controller setting and monitoring tool MELSOFT CW Configurator

Fully supporting all your needs from model selection, system design, startup to maintenance with diverse software

MELSOFT is the FA integrated engineering software that demonstrates their abilities in various FA scenes including designing, debugging and startup, and operation and maintenance to facilitate all aspects from specification review to daily data collection.

<p>Programmable Controller Engineering Software MELSOFT GX Works3</p>	<p>Motion Controller Engineering Software MELSOFT MT Works2</p>	<p>Servo Setup Software MELSOFT MR Configurator2</p>
<p>All-in-one tool for quick and easy startup This software supports the engineering process - from creation of a sequence program, parameter settings of the Simple Motion module, and creation of a positioning data table and cam data through startup, debugging, and maintenance.</p>	<p>Comprehensively supporting Motion controller design and maintenance With features including Motion SFC programming, parameter settings, and the digital oscilloscope function, this software supports the engineering process -from system configuration and programming through debugging and maintenance of the Motion controller.</p>	<p>User-friendly software for easy setup, tuning, and operation Tuning, monitoring, diagnosis, reading/writing parameters, and test operations are easily performed.</p>

System Design

System configuration



Servo amplifiers and modules are set easily with the graphical system setting screen.

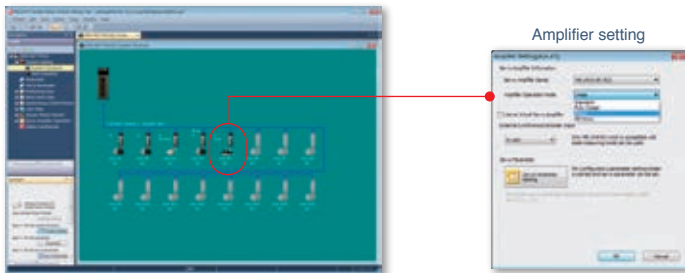

Amplifier setting

Module configuration



Each parameter is set from the module configuration screen.



Servo data setting



One-point help allows you to set parameters without manuals.

Entering just the machine specifications (reduction ratio, ball screw pitch, etc.) sets the electric gear.

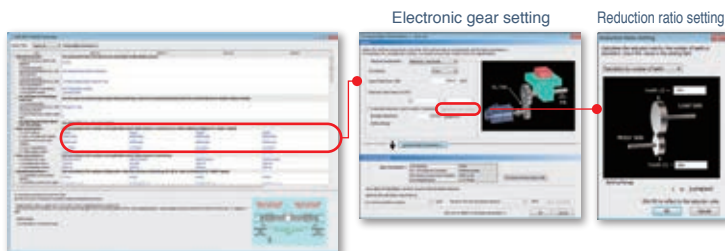

Electronic gear setting

Reduction ratio setting

Copying servo data



Copy & paste of the data between axes is easy.



Right-click on the axis No.

Programming

Positioning data setting



Functions, such as Data setting assistant and Automatic calculation of auxiliary arc, simplify the setting input process of positioning data.

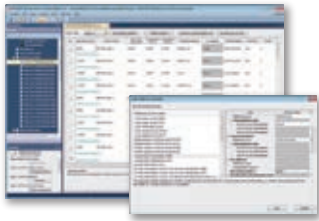

Simulation



Simulation can be executed without an actual machine during the debugging process.

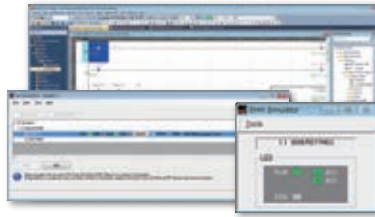

Programming



User-friendly functions make Motion controller program development easier.

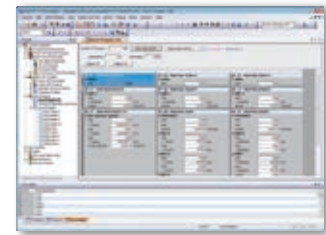

Synchronous control parameter



The synchronous control parameter is easily set using software instead of controlling mechanically with physical gears, shafts, speed change gears or cams.



Cam data creation



Various cam patterns are created more freely and flexibly.

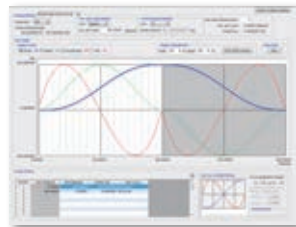

Cam data list



The created cam data are easily viewed as thumbnails.

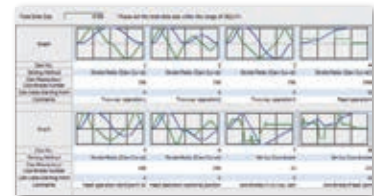

Startup and Adjustment

Monitor



The required items and axes are selected from various monitoring information.



Digital oscilloscope



Data collection and waveform display which are synchronized with the Motion operation cycle greatly help you check operation and perform troubleshooting.



Multi-axis adjustment



The multi-axis adjustment function enables easy servo adjustment and quick startup for machines executing multi-axis simultaneous operation, such as a tandem configuration.



Startup and Adjustment of Servo Amplifier GX Works3 MT Works2 MR Configurator2

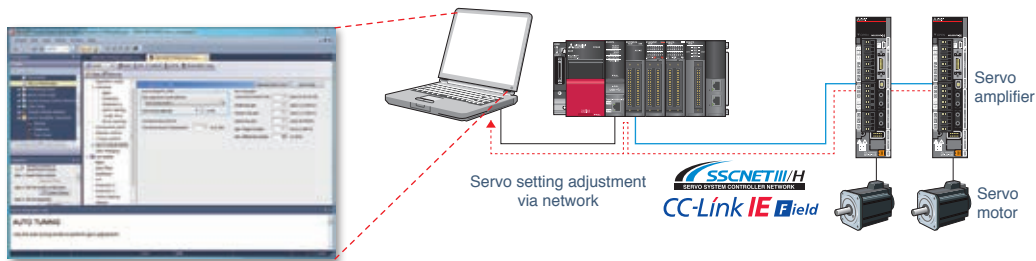

Servo assistant function

Complete setting up the servo amplifier just by following guidance displays.



Parameter setting function

Display parameter setting in list or visual formats, and set parameters by selecting from the drop down list.

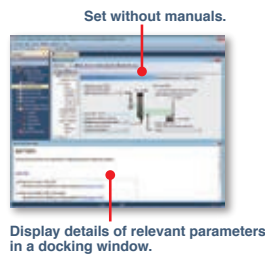

Monitor function

Monitor the operation information on the [Display all] window. The power consumption can also be monitored without additional measurement equipment.

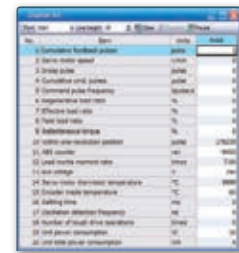

One-touch tuning function

With the ease of clicking the start button, adjustments including estimating load to motor inertia ratio, adjusting gain, and suppressing machine resonance are automatically performed for the maximum servo performance.

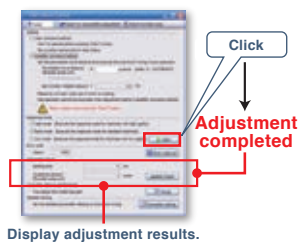

Tuning function

Adjust control gain finely on the [Tuning] window manually for further performance after the one-touch tuning.



Alarm display

MR-J4 series displays the alarm No. in three digits to show the servo alarm in more details, making troubleshooting easy.

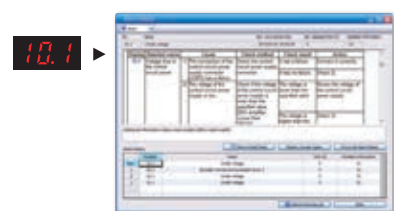

Select the most suitable motor for your machine
Capacity selection software **MRZJW3-MOTSZ11E**

Select the most suitable servo motor, servo amplifier, and regenerative option for your machine just by setting machine specifications and operation pattern.

Select the operation pattern from either position control mode or speed control mode. The capacity selection software is available for free download. Contact your local sales office for more details.



CC-Link IE Field Network

Ethernet-based open network, CC-Link IE Field Network –
All-rounder network opens up new areas of control

This Ethernet-based open network is designed to simultaneously handle distributed control, I/O control, safety control, and Motion control.

Two Times Faster Operation Cycle

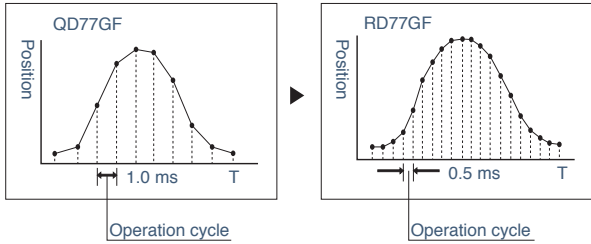

The operation cycle of 0.5 ms, two times faster than the previous model, enables smoother machine control. Smooth control of synchronization, cam control, and S-curve acceleration/deceleration improves the product quality with a shorter cycle time.

Motion Control Achieved

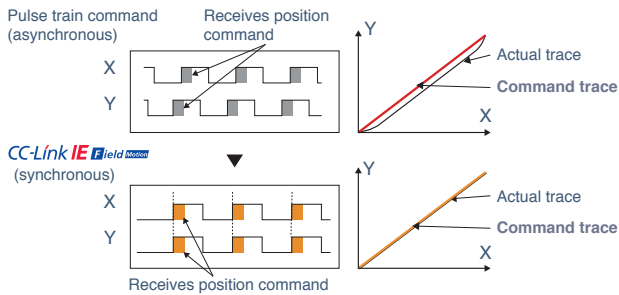

The CC-Link IE Field Network is equipped with Motion function in the cyclic communication bandwidth. Synchronous communication with the servo amplifiers becomes possible, offering high-speed and high-accuracy positioning, synchronous control, and cam control.

Easy Startup

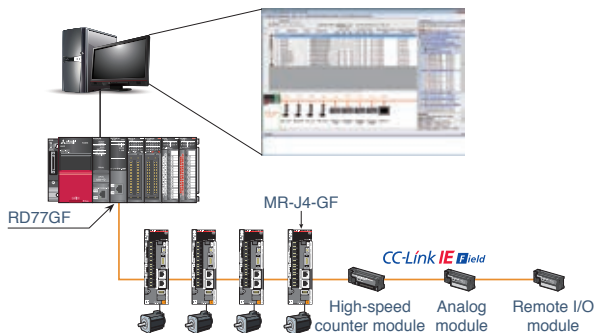

Selecting each field device on the screen of CC-Link IE Field configuration via drag & drop enables easy parameter settings. An addition or a change of field devices are also easily made by modifying the parameters.

All-Rounder Network

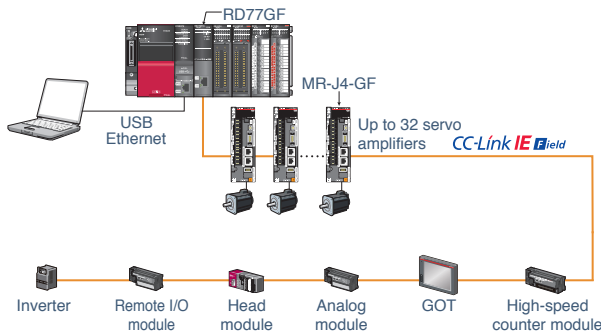

CC-Link IE Field Network is an Ethernet-based open network. The highly flexible wiring of CC-Link IE Field enables versatile control from I/O control to Motion control over the single network. Cables and connectors are highly available in the world as CC-Link IE Field Network is based on the Ethernet.

* Up to 32 servo amplifiers (motion mode) are connectable.

- Slave stations:
- RD77GF: 120 stations (including the number of servo amplifiers in motion mode)
 - QD77GF: 120 stations (16 servo amplifiers in motion mode + 104 I/O devices)

Flexible Network Topology

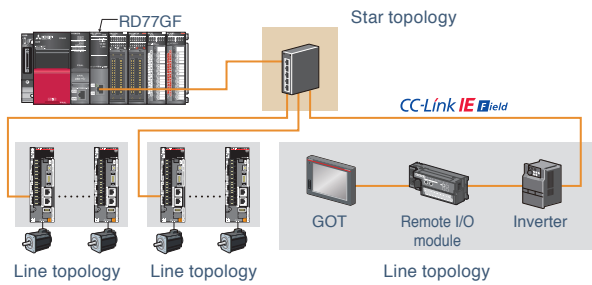

Star, line, and star/line mixed topologies are available for a network configuration by using a switching hub.

When using star topology, be sure to use the following switching hubs:

- Intelligent hub: NZ2MHG-T8F2
- Industrial switching hub: DT135TX (manufactured by Mitsubishi Electric System & Service Co., Ltd.)

Synchronous Communication Function

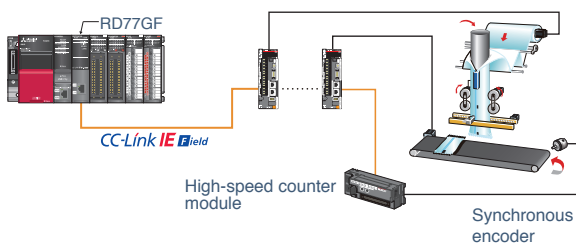

The operation timings of multiple slave units match since the synchronous communication compatible slave devices operate at the operation cycle of the Simple Motion module.

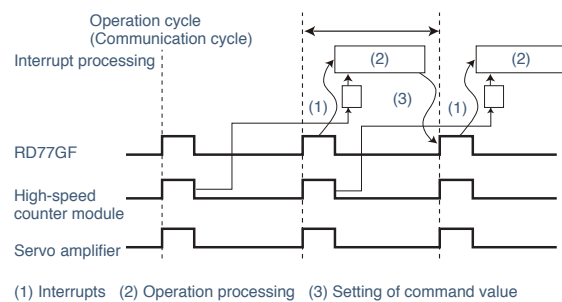

CC-Link IE Field Network Basic

With recent trends of IoT¹, network connection of devices and equipment for small-scale systems are becoming more mainstream. CC-Link IE Field Network Basic realizes easier network integration of Ethernet devices, as its cyclic communications stack is software-based, without requiring a dedicated ASIC helping to reduce implementation costs for device partners. Transparent communications are achieved by utilizing SLMP² that enables seamless connectivity within all levels of manufacturing. CC-Link IE Field Network Basic is supported by MR-J4-GF and MR-JE-C.

CC-Link IE Field Basic

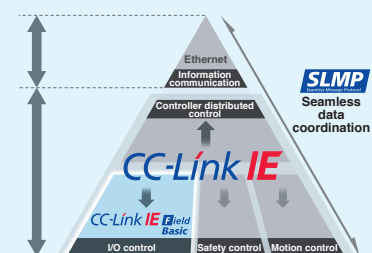

*1. Internet of Things
*2. Seamless Message Protocol

SSCNET III/H

The blazingly fast speed and response of 150 Mbps full-duplex baud rate SSCNET III/H optical networking

SSCNET III/H is a high-speed servo system controller network employing fiber optic cables, enabling high precision synchronization. The communication cycle as fast as 0.222 ms increases responsivity and reduces cycle time of machine. The dedicated fiber optic cable reduces the wiring and makes the setting up so simple.

Three Times Faster Communication Speed

Industry-leading levels

■ Network communication speed

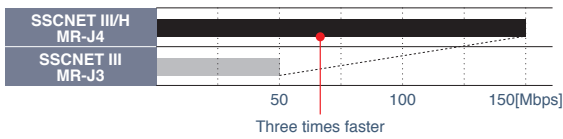

Communication speed is increased to 150 Mbps full duplex (equivalent to 300 Mbps half duplex), three times faster than the conventional speed. System response is dramatically improved.

Cycle Time as Fast as 0.222 ms

Industry-leading levels

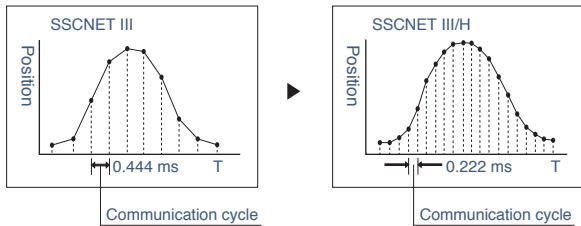

Smooth control of a machine is possible using high-speed serial communication with a cycle time of 0.222 ms.

Synchronous communication

■ Timing of servo amplifier processing

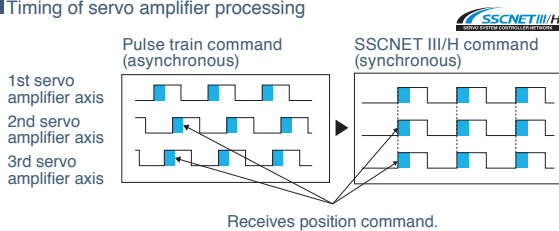

Synchronous communication is achieved with SSCNET III/H, offering technical advantages for machines in printing and food processing industry that require deterministic control.

Improved Noise Tolerance by Optical Communication

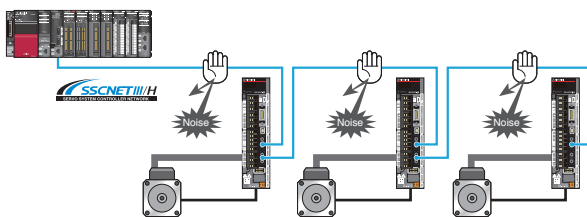

Hand icon Guards against noise.

The fiber-optic cables thoroughly shut out noise that enters from the power cable or external devices. Noise tolerance is dramatically improved as compared to metal cables.

Long Distance Wiring up to 3200 m

Enhanced performance

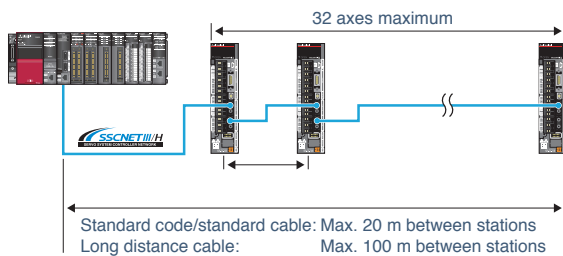

Long distance wiring is possible up to 3200 m per system (maximum of 100 m between stations × 32 axes), suitable for large-scale systems.

Maximum overall distance per system
 Standard code/standard cable: 640 m (20 m × 32 axes)
 Long distance cable: 3200 m (100 m × 32 axes)

Central Control with Network

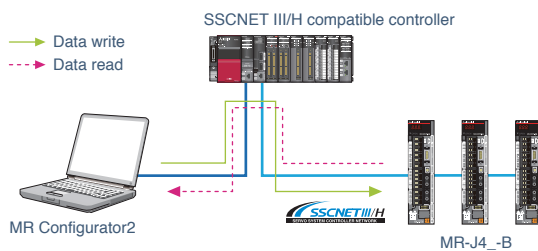

Large amounts of servo data are exchanged in real-time between the controller and the servo amplifier. Using MR Configurator2 on a personal computer that is connected to the Motion controller or the Simple Motion module helps consolidate information, such as parameter settings and monitoring for the multiple servo amplifiers.

Network Topology

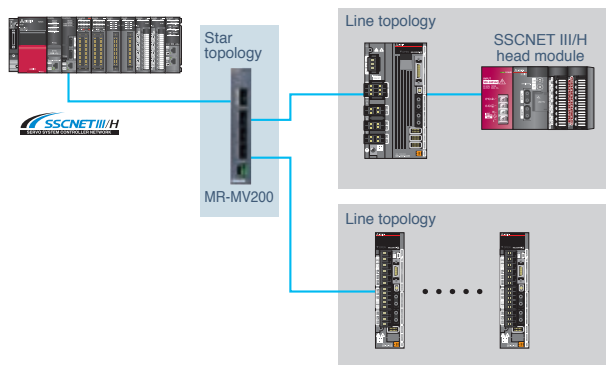

Star and line topologies are available with MR-MV200 optical hub unit through SSCNET III/H for a network configuration. Maintenance can be executed without stopping the whole system, and thus the machine availability will be increased.

I/O Signals Synchronized with Motion Control

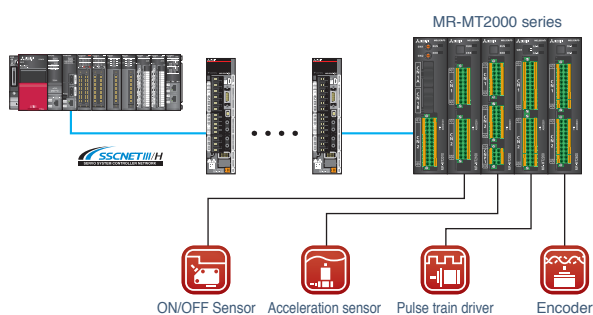

MR-MT2000 series sensing modules including the I/O module, analog I/O module, pulse I/O module, and encoder I/F module are connected to SSCNET III/H.

These various modules enable a faster, more accurate machine operation by synchronizing the I/Os of a general-purpose pulse train driver, sensor, and SSI encoder with the motion control.

Selection of Servo System Controller

Select the type of servo system controller roughly on the basis of control method after selecting a PLC CPU. Next, select the optimal servo system controller that suits your application on the basis of connecting devices, performance/program types, and functions.



Model Selection of PLC CPU and Controller

Medium- to large-scale control

MELSEC iQ-R series



A next-generation programmable automation controller (PAC), the MELSEC iQ-R series resolves your tasks as the core of the automation system by integrating high-performance capabilities based on the high-end iQ-R system bus, inter-module synchronization, and high precision processing achieved by synchronization between high-speed networks.

MELSEC Q series

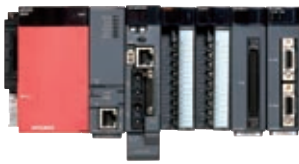

The first to incorporate the multiple CPU architecture, the MELSEC-Q series wide-range of CPUs enables control of multiple operations, improving the performance and scalability of the overall production system.

Small- to medium-scale control

MELSEC L series



The MELSEC-L series is a baseless highly scalable controller ideal for applications having limited space. With various I/O functionality embedded into the CPU module, high performance is achieved in a compact body.

Small-scale and stand-alone

MELSEC iQ-F series



Designed to provide outstanding performance and superior drive control, the MELSEC iQ-F series is a high-performance compact-class controller with a rich assortment of integrated functions.

MELSEC-F



Incorporating abundant features with a flexible system configuration, the MELSEC-F series has a power supply, CPU, and I/Os into a single compact body.

Motion control by C Language based programming



High-response servo control can be performed with a combination of the Position Board and a personal computer, or the C Controller Interface Module and the C Controller.

Model Selection by Control Method

Select the controller on the basis of control method, program, and command interface.

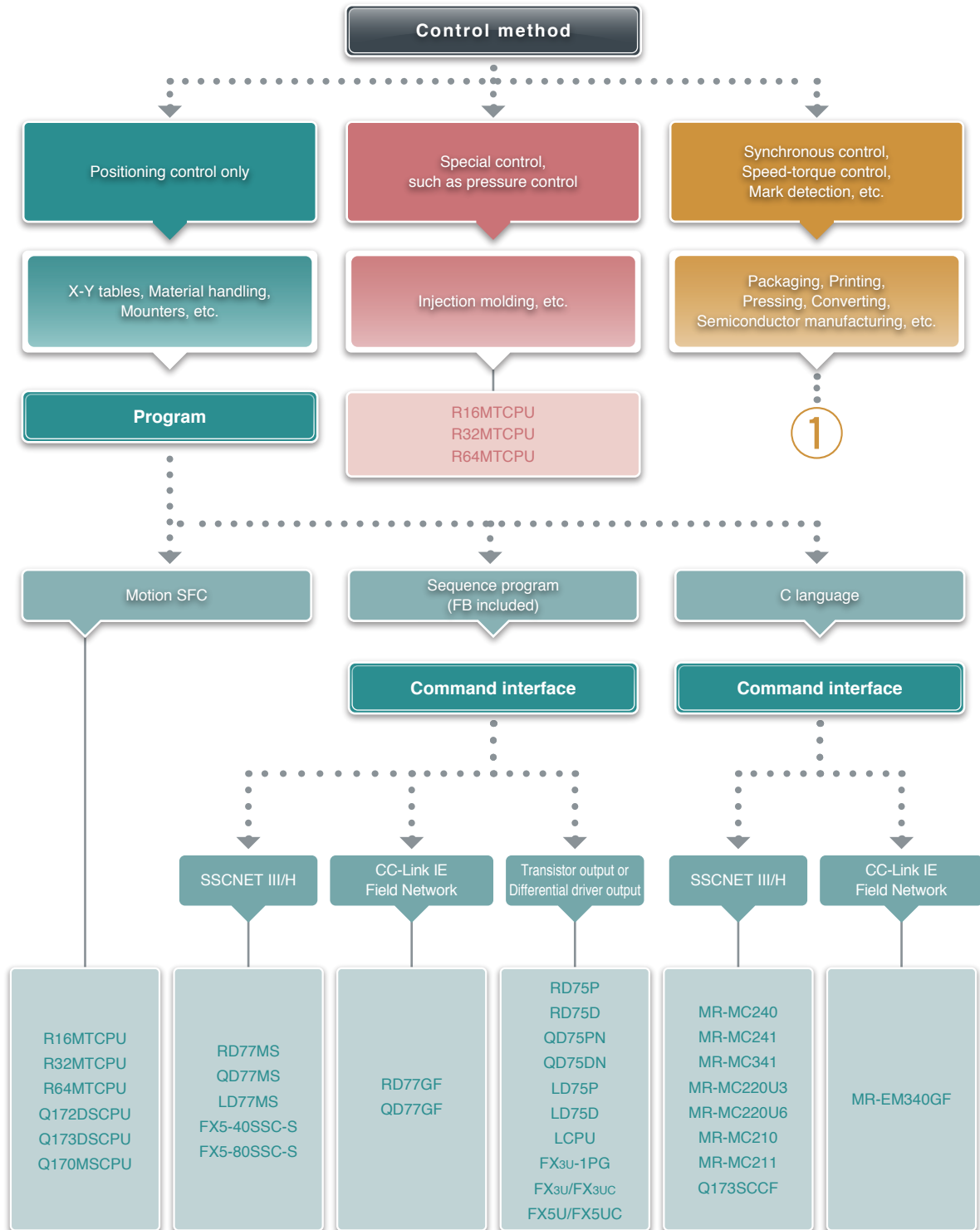

* For RnMTCPU, add-on libraries can be additionally installed. With "G-code control add-on library" (not free of charge), the controller can control a processing machine using general-purpose AC servo system. With an add-on library "machine library" (free of charge), the controller can control a simplified robot (link configuration).

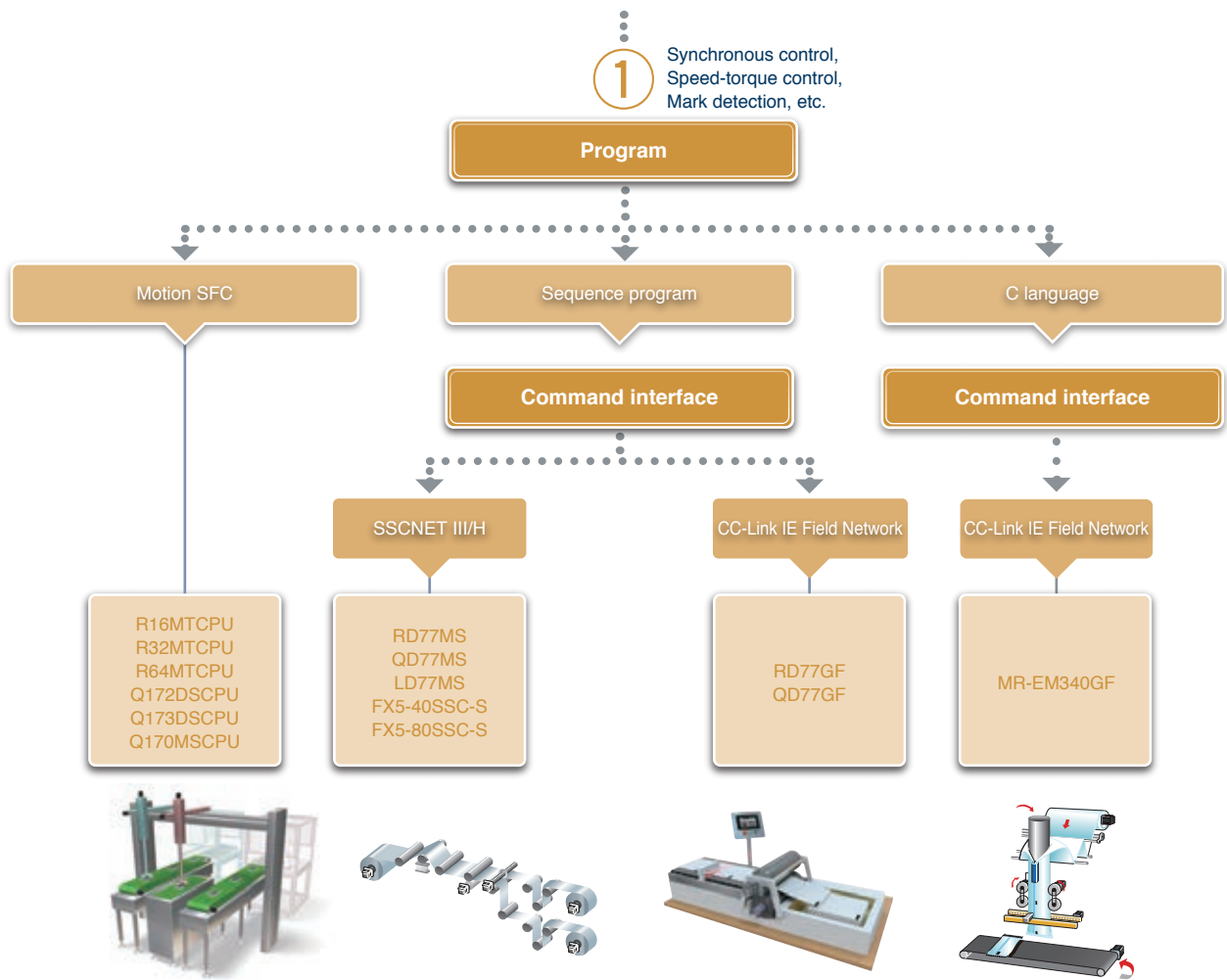

Model Selection of PLC CPU

Select the PLC CPU in consideration of the size and expandability of the equipment.

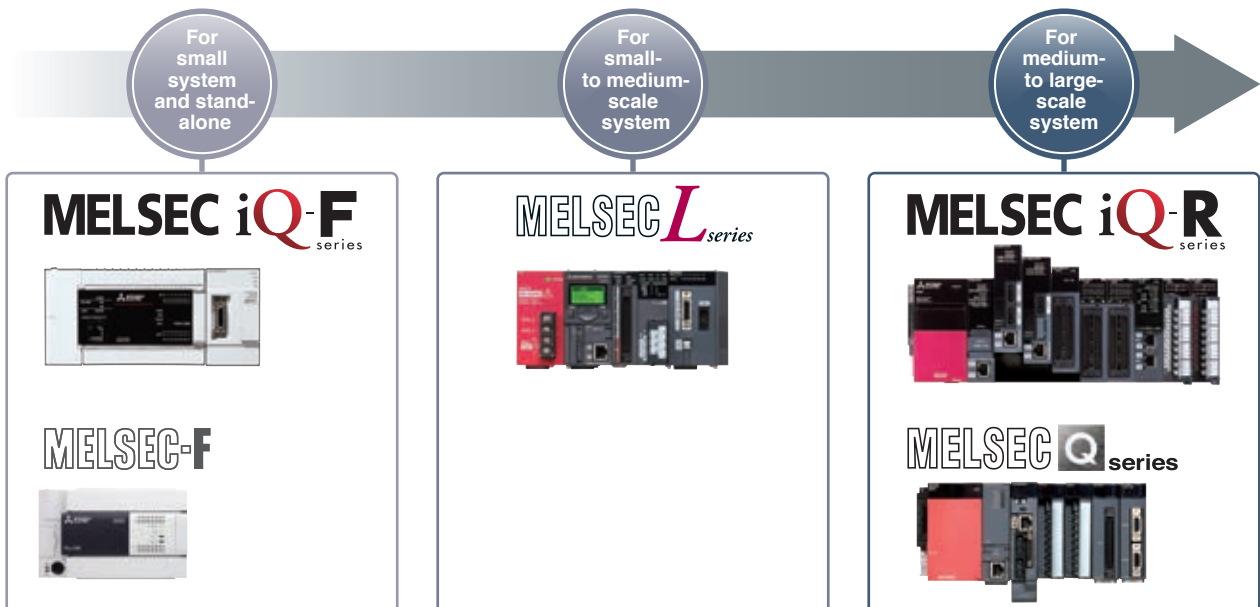

Product Lines

Programmable controller	Model		Engineering software	Command interface	MELSERVO-J4		MELSERVO-JE	
					Servo amplifier	Servo motor	Servo amplifier	Servo motor
MELSEC iQ-R series	CPU module	RnCPU RnENCPU	GX Works3	CC-Link IE Field Basic	MR-J4-GF		MR-JE-C	
		Simple Motion module	RD77GF	GX Works3			CC-Link IE Field	—
	RD77MS		GX Works3	SSCNET/IIH	MR-J4(W)-B	MR-JE-B		
	Motion controller	RnMTCPU	GX Works3 MT Works2		—	—	—	
	Positioning module	RD75P RD75D	GX Works3	Transistor output Differential driver output	MR-J4-A		MR-JE-C MR-JE-A	
MELSEC-Q series *3	Simple Motion module	QD77GF	GX Works2	CC-Link IE Field	MR-J4-GF		—	—
		QD77MS	GX Works2	SSCNET/IIH	MR-J4(W)-B	MR-JE-B		
	Motion controller	Q17nDSCPU Q170MDCPU	GX Works2 MT Works2		—	—	—	
	Positioning module	QD75PN QD75DN	GX Works2	Transistor output Differential driver output	MR-J4-A		MR-JE-C MR-JE-A	
		QD70P QD70D	GX Works2	Transistor output Differential driver output				
MELSEC-L series *3	CPU module	LCPU	GX Works2	Transistor output	MR-J4-A		MR-JE-C MR-JE-A	
	Simple Motion module	LD77MS	GX Works2	SSCNET/IIH	MR-J4(W)-B		MR-JE-B	
	Positioning module	LD75P LD75D	GX Works2	Transistor output Differential driver output	MR-J4-A		MR-JE-C MR-JE-A	
MELSEC iQ-F series	CPU module	FX5U FX5UC	GX Works3	CC-Link IE Field Basic	MR-J4-GF		MR-JE-C	
		GX Works3	Transistor output	MR-J4-A	MR-JE-A MR-JE-C			
	Simple Motion module	FX5-40SSC-S FX5-80SSC-S	GX Works3	SSCNET/IIH	MR-J4(W)-B	MR-JE-B		
MELSEC-F series	CPU module	FX5u FX5uc	GX Works2	Transistor output	MR-J4-A		MR-JE-C MR-JE-A	
	Positioning module	FX5u-1PG	GX Works2	Transistor output				
Personal computer	Board type controllers	MR-EM340GF	EM Software Development Kit *1	CC-Link IE Field	MR-J4-GF	—	—	
		MR-MC2_0 MR-MC2_1 MR-MC341	*1	SSCNET/IIH	MR-J4(W)-B	MR-JE-B		
		C Language compatible module	Q173SCCF	*2	SSCNET/IIH	MR-J4(W)-B	MR-JE-B	

*1. Be sure to prepare the development environment in which Microsoft Visual Studio® can be used.
 *2. CW Workbench/Wind River Workbench, and Setting/monitoring tool for the C Language Controllers
 *3. MELSEC Q and MELSEC L series also support CC-Link IE Field Network Basic.

Performance/Program

Programmable controller	Model		Maximum number of control axes	Operation cycle	Positioning program						Electronic gear
					Motion profile table	Synchronous control parameter	Motion SFC	G-code ^{*1} , Machine control	Sequence program	C language	
MELSEC iQ-R series	CPU module	RnCPU RnENCPU	Depends on the master station	Depends on the master station	—	—	—	—	●	—	—
	Simple Motion module	RD77GF	32	0.5 ms or longer	●	●	—	—	●	—	●
		RD77MS	16	0.444 ms or longer	●	●	—	—	●	—	●
	Motion controller	RnMTCPU	64	0.222 ms or longer	—	●	●	●	●	—	●
	Positioning module	RD75P RD75D	4	—	●	—	—	—	●	—	●
MELSEC-Q series	Simple Motion module	QD77GF	16	1 ms or longer	●	●	—	—	●	—	●
		QD77MS	16	0.888 ms or longer	●	●	—	—	●	—	●
	Motion controller	Q17nDSCPU Q170MSCPU	32 16	0.222 ms or longer	—	●	●	—	●	—	●
	Positioning module	QD75PN QD75DN	4	—	●	—	—	—	●	—	●
		QD70P QD70D	8	—	●	—	—	—	●	—	—
MELSEC-L series	CPU module	LCPU	2	—	●	—	—	—	●	—	—
	Simple Motion module	LD77MS	16	0.888 ms or longer	●	●	—	—	●	—	●
	Positioning module	LD75P LD75D	4	—	●	—	—	—	●	—	●
MELSEC iQ-F series	CPU module	FX5U FX5UC	Depends on the master station	Depends on the master station	—	—	—	—	●	—	—
	CPU module	FX5U FX5UC	4	—	—	—	—	—	●	—	—
	Simple Motion module	FX5-40SSC-S FX5-80SSC-S	4 8	0.888 ms or longer	●	●	—	—	●	—	●
MELSEC-F series	CPU module	FXsu FXsuc	3	—	—	—	—	—	●	—	—
	Positioning module	FXsu-1PG	1	—	—	—	—	—	●	—	—
Personal computer	Board type controllers	MR-EM340GF	16	0.5 ms or longer	●	●	—	—	—	●	●
		MR-MC2_0 MR-MC2_1 MR-MC341	20 32 64	0.222 ms or longer	●	—	—	—	—	●	●
MELSEC-Q series	C Language compatible module	Q173SCCF	20	0.222 ms or longer	●	—	—	—	—	●	●

*1. "G-code control add-on library" (provided for a fee) is additionally required. With the library, control of a processing machine using AC servo is possible.

Function comparison

	MELSEC iQ-R				MELSEC-Q			
	RD77GF4 RD77GF8 RD77GF16 RD77GF32	RD77MS2 RD77MS4 RD77MS8 RD77MS16	R16MTCPU R32MTCPU R64MTCPU	RD75P2 RD75D2 RD75P4 RD75D4	QD77GF4 QD77GF8 QD77GF16	QD77MS2 QD77MS4 QD77MS16	Q172DSCPU Q173DSCPU Q170MSCPU Q170MSCPU-S1	QD75P1N QD75D1N QD75P2N QD75D2N QD75P4N QD75D4N
Position control	●	●	●	●	●	●	●	●
Speed control	●	●	●	●	●	●	●	●
Torque control	●	●	●	—	●	●	●	—
Tightening & press-fit control	—	●	●	—	—	●	●	—
Advanced synchronous control	●	●	●	—	●	●	●	—
Cam control	●	●	●	—	●	●	●	—
Linear interpolation	●	●	●	●	●	●	●	●
Circular interpolation	●	●	●	●	●	●	●	●
Continuous trajectory control	●	●	●	●	●	●	●	●
Speed/position switching control	●	●	●	●	●	●	●	●
Position follow-up control	—	—	●	—	—	—	●	—
Helical interpolation	●	●	●	●	—	—	●	●
Trapezoidal acceleration/deceleration	●	●	●	●	●	●	●	●
S-curve acceleration/deceleration	●	●	●	●	●	●	●	●
Advanced S-curve acceleration/deceleration	—	—	●	—	—	—	●	—
JOG operation	●	●	●	●	●	●	●	●
Manual pulse generator operation	●	●	●	●	●	●	●	●
Current value change	●	●	●	●	●	●	●	●
Target position change	●	●	●	●	●	●	●	●
Speed change	●	●	●	●	●	●	●	●
Override	●	●	●	●	●	●	—	●
Acceleration/deceleration time change	●	●	●	●	●	●	●	●
Home position return	●	●	●	●	●	●	●	●
Absolute position system	●	●	●	Simple ver.	●	●	●	Simple ver.
Unlimited length feed	●	●	●	●	●	●	●	●
Optional data monitor	●	●	●	—	●	●	●	—
Mark detection	●	●	●	—	●	●	●	—
Event history	●	●	●	●	—	—	—	—
Cam auto-generation	●	●	●	—	●	●	●	—
Driver communication	—	●	●	—	—	●	●	—
Digital oscilloscope	●	●	●	—	●	●	●	—
Vision system	—	—	●	—	—	—	●	—
Security key	—	—	●	—	—	—	●	—

*1. Available only with QD70D.
*2. Available only with MR-MC341.

MELSEC-Q	MELSEC-L		MELSEC iQ-F		MELSEC-F		MELSEC-Q	Personal computer	
QD70P4 QD70D4 QD70P8 QD70D8	LD77MS2 LD77MS4 LD77MS16	LD75P1 LD75D1 LD75P2 LD75D2 LD75P4 LD75D4	FX5-40SSC-S FX5-80SSC-S	FX5U FX5UC	FX3U FX3UC	FX3U-1PG	Q173SCCF	MR-EM340GF	MR-MC240 MR-MC241 MR-MC341 MR-MC220U3 MR-MC220U6 MR-MC210 MR-MC211
●	●	●	●	●	●	●	●	●	●
—	●	●	●	●	●	●	●	●	●
—	●	—	●	—	—	—	●	●	●
—	●	—	●	—	—	—	●	—	●
—	●	—	●	—	—	—	—	●	—
—	●	—	●	—	—	—	—	●	—
—	●	●	●	Simple ver.	—	—	●	●	●
—	●	●	●	—	—	—	—	●	*2
●	●	●	●	●	—	—	●	●	●
●	●	●	●	—	—	—	—	●	—
—	—	—	—	—	—	—	—	—	—
—	—	●	—	—	—	—	—	●	—
●	●	●	●	●	●	●	●	●	●
*1	●	●	●	—	—	●	●	●	●
—	—	—	—	—	—	—	—	—	—
●	●	●	●	●	●	●	●	●	●
—	●	●	●	—	—	—	—	●	—
●	●	●	●	—	—	—	—	●	—
*1	●	●	●	●	—	●	●	●	●
●	●	●	●	●	—	●	●	●	●
—	●	●	●	—	—	—	—	●	—
—	●	●	●	—	—	—	●	●	●
●	●	●	●	●	●	●	●	●	●
—	●	Simple ver.	●	●	●	Simple ver.	●	●	●
—	●	●	●	●	—	●	—	●	—
—	●	—	●	—	—	—	●	●	●
—	●	—	●	—	—	—	●	●	●
—	—	—	—	—	—	—	●	●	●
—	●	—	●	—	—	—	—	●	—
—	●	—	●	—	—	—	—	—	—
—	●	—	●	—	—	—	●	●	●
—	—	—	—	—	—	—	—	—	—
—	—	—	—	—	—	—	—	—	—

Solutions

MELSERVO Solution

Introducing the MELSERVO solutions for problems in production sites.
We offer the optimal solutions for various problems in various production sites.

Applications

- Vertical form, fill & seal
- Rotary knives
- Motion alignment (X-Y- θ)
- Gantry applications
- Pick and place robots
- Press-fit machines
- Conveyor systems utilizing safety observation function
- Eco-friendly conveyors and product handling equipment
- Converting systems
- Screw tightening machines
- Automated guided vehicles
- Flying shears

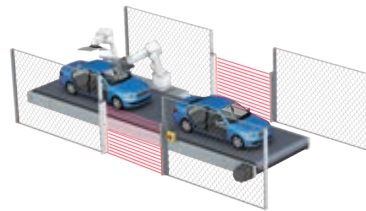
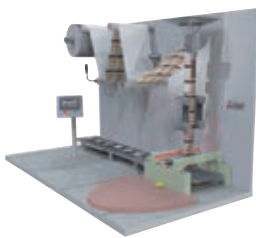

Exceptional Solutions for All of Your Production Needs
Refer to "MELSERVO SOLUTIONS catalog (L(NA)03094)" for details.

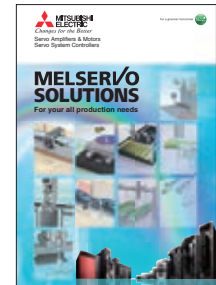

Function Guide

Introducing the latest functions for easier and safer operations.
MELSERVO-J4 and our servo products come with a wide selection of functions to solve the challenges in production.

- Failure Prediction
- Drive Recorder
- Master-Slave Operation
- Super Trace Control
- Simple Cam
- Functional Safety
- Monitoring
- One-Touch Tuning
- Multi-Axis Adjustment
- Pressure Control

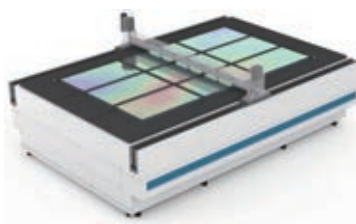

Refer to "MELSERVO-J4 Function Guide (L(NA)03152ENG)" for details.

Mitsubishi Electric FA Application Package iQ Monozukuri

Offering concentrates on improving the productivity, quality, and concepts for achieving process improvements associated with the construction and configuration of applications, and devices.

- **CONVERTING** Strongly supporting development of converting systems with unwinder/rewinder control
- **HANDLING** Strongly supporting development of transportation mechanisms with calculation of coordinate transformation
- **PACKAGING** Strongly supporting development of packaging machines with cam control and positioning compensation



e-F@ctory Alliance

The e-F@ctory Alliance is an FA manufacturer partnering program that strongly links the connection compatibility of Mitsubishi Electric FA equipment utilizing excellent software and machinery offered by partners, thereby enabling systems to be built by systems integration partners and the proposal of optimal solutions to customers.



Mitsubishi Electric Servo System Partners

Servo system includes controllers, servo drivers, actuators, sensors, etc. The servo system takes a step further to accelerate the equipment revolution by collaborating with our partner companies. Now that a wide variety of partner products are available such as pressure-resistance, explosion-proof type motors, custom-made servo motors, magnetic type linear encoders, your system will be configured flexibly. The Mitsubishi Electric Servo System Partner Association is a subcommittee of e-F@ctory Alliance.

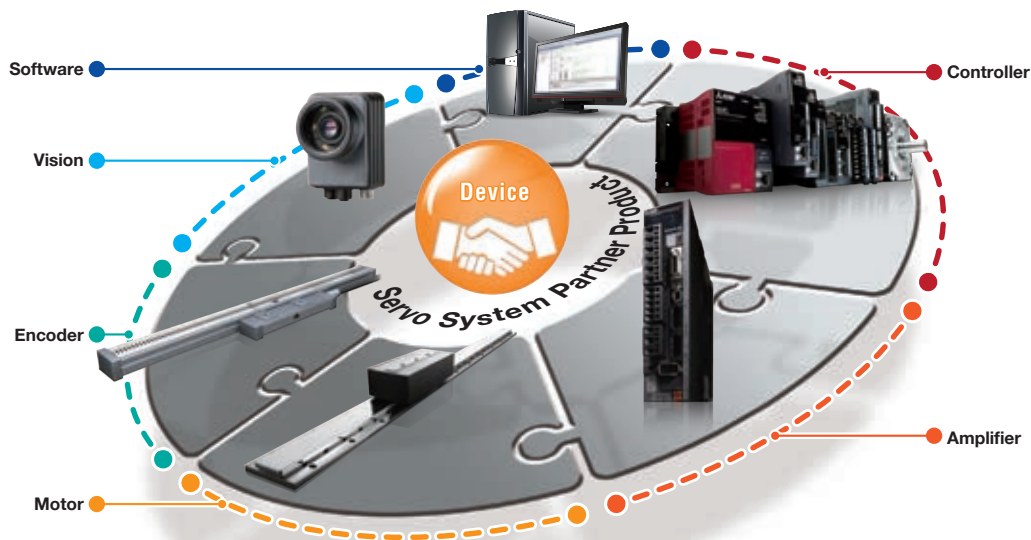

Production System

Homes of MELSERVO where the advanced FA technologies are incorporated.

To guarantee the high quality and performance of MELSERVO, Mitsubishi Electric has built a cooperative system of three facilities - Shinshiro Factory, a branch factory of Nagoya Works; MEAMC (Mitsubishi Electric Automation Manufacturing (Changshu) Co., Ltd.) a manufacturing base; and Nagoya Works at the core. Mitsubishi Electric responds to customer needs throughout the world by uniting technologies and know-hows of these facilities.

Nagoya Works

Integrated manufacturing of servo amplifiers, servo motors, and other Mitsubishi Electric's servo system products.



Nagoya Works was established in 1924 as Mitsubishi Electric's first mass-production factory for electric motors. The lineup of factory automation and mechatronics products has continued to expand gradually since the advent of high economic growth in Japan. Along with its numerous successful achievements, Nagoya Works continues to actively develop solutions for improving productivity and quality.

Number of employees	2,500
Site area	306,000 m ²
Gross floor space	Approx. 252,000 m ² (Satellite factories excluded)

Shinshiro Factory

Mitsubishi Electric's servo motor manufacturing facility.



Shinshiro Factory was established in 1974 as a satellite factory of Nagoya Works, supplying various types of motors built utilizing the latest mechatronic and system technologies. Moreover, the integrated FA solution e-F@ctory was introduced for the motor shaft processing line, which utilizes many special components. The productivity of the production line has been improved, and the factory is now able to handle multi-model, small-lot production in a shorter period of time.

Number of employees	100
Site area	130,000 m ²
Gross floor space	42,000 m ²

MEAMC

(Mitsubishi Electric Automation Manufacturing (Changshu) Co., Ltd.)

AC servo manufacturing facility in China



MEAMC was established in June 2011 in Changshu, China, as a manufacturing base. Operations at Factory 2 started in April 2017 in response to the increasing demands for controllers and drive products in China and around the world. FA integrated solution, "e-F@ctory", has been implemented in the manufacturing line to improve productivity and conserve energy.

Number of employees	490
Site area	63,910 m ²
Gross floor space	44,810 m ²

Key parts of own manufacturing on unique technology



In the advanced production system integrating the production management system and the FA system based on IT, key components such as power modules and servo-motor encoders for drive control devices and oscillators and lenses for laser machining equipment are manufactured in our company by making the best use of unique technologies. This strategic facility is indispensable for Nagoya Works to enhance competitiveness of its products and to add values to the products.

Passing on technologies developed to future generations



Manufacturing is an achievement of advanced technologies, and at the same time, it is the result of skills passed from person to person. Nagoya Works periodically holds Nagoya Works Technology School, in which educational sessions are conducted where senior engineers teach younger engineers techniques and procedures such as machining, finishing, welding, and assembly of electronic components. The skills developed are passed on to future generations as precious resources of manufacturing.

Painstaking quality assurance through the application of cutting-edge testing equipment.



Ultrasonic Probing Devices



LSI testers



X-ray scanners



EMC chamber
(large-size anechoic chamber)



Equipment for highly accelerated limit test (HALT)

R&D

World-class R&D capabilities to offer a unique set of servo systems.

To bring cutting-edge servo systems to worldwide market, Mitsubishi Electric has established FA-related development centers in its Nagoya Works, Europe, the U.S., and India.

Together with our Advanced Technology R&D Center, and Information and Technology R&D Center, we are moving forward with the development of new products to correspond to technology trends and the voices of our customers.

Japan (Nagoya Works)

FA Development Center



Integrating product-development ability as a comprehensive FA supplier

The FA Development Center is comprised of engineers who specialized in controllers and drive system products. Its function is to promote higher product compatibility and integration, as well as improve the overall performance of Mitsubishi Electric FA products by merging the respective technologies of different parties at a high level. The newly added Experiment and Verification Room is used for joint development projects with customers and development partners. The Center has a secure Internet environment, and the connection status of our FA devices and software can be assessed easily. This shortens the development timeframe and enables us to be one step ahead in creating FA products that connect to the world and meet the needs of the IoT era.

In addition, the number of prototypes necessary in the product planning, development, design and prototype phases has been reduced through simulation technology built in a virtual environment. The product development timeframe has also been shortened and design quality improved by reducing the man-hours required for evaluation.

Mechatronics Development Center

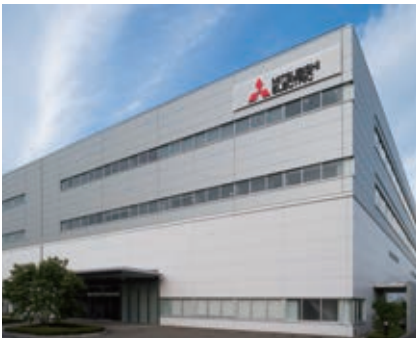

Advanced base for advantage of technology and development of industrial mechatronics products

In addition to FA devices, industrial mechatronics products are another major product line manufactured at Nagoya Works. The Mechatronics Development Center is the development base for these products. It has established advanced machining technologies that enable highly accurate ultrafine machining at the nanometer-level, and works to improve development efficiency and reduce development time by seamlessly linking itself with relevant technological organizations. It is also utilized for joint development projects with our customers, leading to the creation of products that can be used, and new applications and new markets.

Japan (Mitsubishi Electric R&D)

Advanced Technology R&D Center



The Advanced Technology R&D Center engages in next-generation product development utilizing the fundamental technologies that underpin our business and R&D, which helps to sow the seeds for new business in the future and aims to create new values accepted by society.

Information and Technology R&D Center



As the main base for information and communication technology development, the Information and Technology R&D Center conducts R&D in the fields of information, multimedia, optic radio waves and communication technologies and solution proposal-type development utilizing IT.

Global Development Centers

Global development centers and Mitsubishi Electric domestic laboratories collaborating to lead the world in product development

European Development Center (EDC)



North American Development Center (NADC)



India Development Center (INDC)



China Development Center (CDC)



History of Mitsubishi Electric Servo System

Passing our technologies and experiences from one generation to the next, Mitsubishi Electric continuously strives for cutting-edge technology.

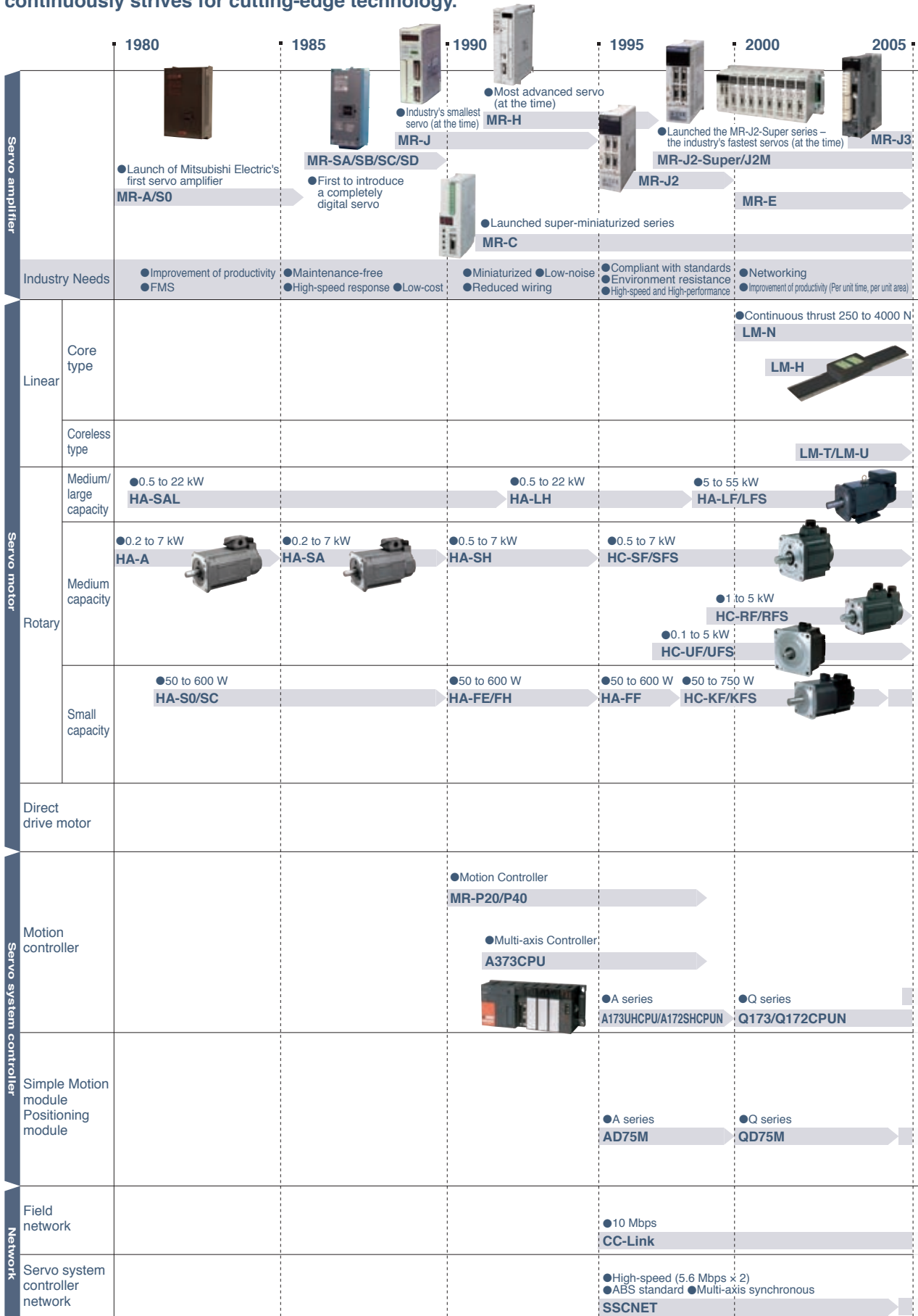

In 1987, Mitsubishi Electric announced MELSERVO-SA, the first completely digital hardware logic product at a time when analog products were at their zenith. Since then, we have pioneered servo technology in Japan. Carrying that heritage forward, we will continuously offer you globally-acknowledged servo systems that completely satisfy your needs.



Global FA Centers

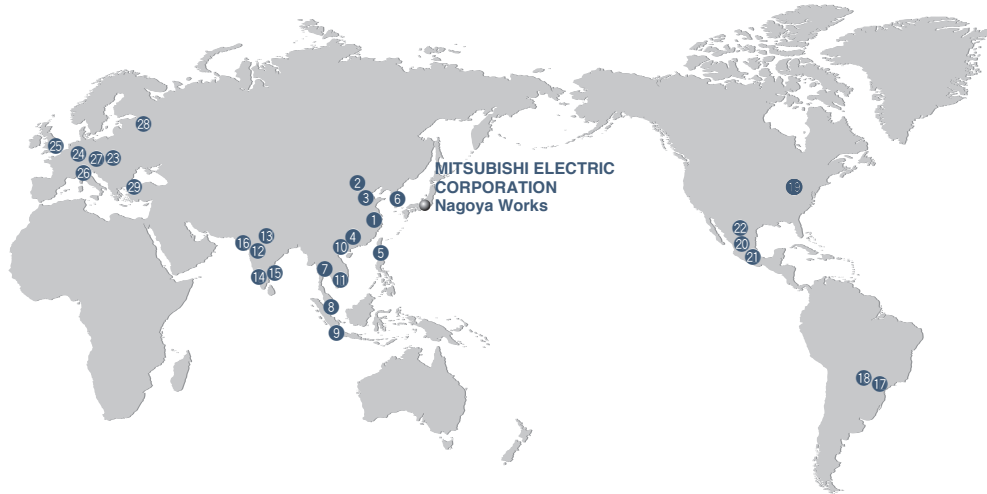

China

1 Shanghai FA Center
Mitsubishi Electric Automation (China) Ltd.
Shanghai FA Center

Mitsubishi Electric Automation Center, No.1386 Hongqiao Road, Shanghai, China
Tel: +86-21-2322-3030

2 Beijing FA Center
Mitsubishi Electric Automation (China) Ltd.
Beijing FA Center

5/F, ONE INDIGO, 20 Jiuxiangqiao Road Chaoyang District, Beijing, China
Tel: +86-10-6518-8830

3 Tianjin FA Center
Mitsubishi Electric Automation (China) Ltd.
Tianjin FA Center

Room 2003 City Tower, No.35, Youyi Road, Hexi District, Tianjin, China
Tel: +86-22-2813-1015

4 Guangzhou FA Center
Mitsubishi Electric Automation (China) Ltd.
Guangzhou FA Center

Room 1609, North Tower, The Hub Center, No.1068, Xingang East Road, Haizhu District, Guangzhou, China
Tel: +86-20-8923-6730

Taiwan

5 Taipei FA Center
SETSUYO ENTERPRISE CO., LTD.

3F, No.105, Wugong 3rd Road, Wugu District, New Taipei City 24889, Taiwan
Tel: +886-2-2299-9917

Korea

6 Korea FA Center
Mitsubishi Electric Automation Korea Co., Ltd.

8F, Gangseo Hangang Xi-tower A, 401, Yangcheon-ro, Gangseo-Gu., Seoul 07528, Korea
Tel: +82-2-3660-9630

Thailand

7 Thailand FA Center
Mitsubishi Electric Factory Automation
(Thailand) Co., Ltd.

12th Floor, SV.City Building, Office Tower 1, No. 896/19 and 20 Rama 3 Road, Kwaeng Bangpompang, Knet Yannawa, Bangkok 10120, Thailand
Tel: +66-2682-6522 to 31

ASEAN

8 ASEAN FA Center
Mitsubishi Electric Asia Pte. Ltd.

307 Alexandra Road, Mitsubishi Electric Building, Singapore 159943
Tel: +65-6470-2480

Indonesia

9 Indonesia FA Center
PT. Mitsubishi Electric Indonesia
Cikarang Office

Jl. Kenari Raya Blok G2-07A Delta Silicon 5, Lippo Cikarang - Bekasi 17550, Indonesia
Tel: +62-21-2961-7797

Vietnam

10 Hanoi FA Center
Mitsubishi Electric Vietnam Company Limited
Hanoi Branch Office

6th Floor, Detech Tower, 8 Ton That Thuyet Street, My Dinh2 Ward, Nam Tu Liem District, Hanoi, Vietnam
Tel: +84-4-3937-8075

11 Ho Chi Minh FA Center
Mitsubishi Electric Vietnam Company Limited

Unit 01-04, 10th Floor, Vincom Center, 72 Le Thanh Ton Street, District 1, Ho Chi Minh City, Vietnam
Tel: +84-8-3910-5945

India

12 India Pune FA Center
Mitsubishi Electric India Pvt. Ltd.
Pune Branch

Emerald House, EL-3, J Block, M.I.D.C., Bhosari, Pune - 411026, Maharashtra, India
Tel: +91-20-2710-2000

13 India Gurgaon FA Center
Mitsubishi Electric India Pvt. Ltd.
Gurgaon Head Office

2nd Floor, Tower A & B, Cyber Greens, DLF Cyber City, DLF Phase - III, Gurgaon - 122002, Haryana, India
Tel: +91-124-463-0300

14 India Bangalore FA Center
Mitsubishi Electric India Pvt. Ltd.
Bangalore Branch

Prestige Emerald, 6th Floor, Municipal No.2, Madras Bank Road, Bangalore - 560001, Karnataka, India
Tel: +91-80-4020-1600

15 India Chennai FA Center
Mitsubishi Electric India Pvt. Ltd.
Chennai Branch

Citilights Corporate Centre No. 1, Vivekananda Road, Srinivasa Nagar, Chetpet, Chennai - 600031, Tamil Nadu, India
Tel: +91-4445548772

16 India Ahmedabad FA Center
Mitsubishi Electric India Pvt. Ltd.
Ahmedabad Branch

B/4, 3rd Floor, SAFAL Profitaire, Corporate Road, Prahaladnagar, Satellite, Ahmedabad - 380015, Gujarat, India
Tel: +91-7965120063

Brazil

17 Brazil FA Center
Mitsubishi Electric do Brasil Comercio e Servicos Ltda.

Avenida Adelino Cardana, 293, 21 andar, Bethaville, Barueri SP, Brazil
Tel: +55-11-4689-3000

18 Brazil Votorantim FA Center
MELCO CNC do Brasil Comercio e Servicos S.A.

Avenida Gisele Constantino, 1578, Parque Bela Vista-Votorantim-SP, Brazil
Tel: +55-15-3023-9000

Americas

19 North America FA Center
Mitsubishi Electric Automation, Inc.

500 Corporate Woods Parkway, Vernon Hills, IL 60061, U.S.A.
Tel: +1-847-478-2100

20 Mexico City FA Center
Mitsubishi Electric Automation, Inc.
Mexico Branch

Mariano Escobedo #69, Col.Zona Industrial, Tlalnepanitla Edo. Mexico, C.P.54030
Tel: +52-55-3067-7511

21 Mexico FA Center
Mitsubishi Electric Automation, Inc.
Queretaro Office

Parque Tecnológico Innovacion Queretaro Lateral Carretera Estatal 431, Km 2 200, Lote 91 Modulos 1 y 2 Hacienda la Machorra, CP 76246, El Marques, Queretaro, Mexico
Tel: +52-442-153-6014

22 Mexico Monterrey FA Center
Mitsubishi Electric Automation, Inc.
Monterrey Office

Plaza Mirage, Av. Gonzalitos 460 Sur, Local 28, Col. San Jeronimo, Monterrey, Nuevo Leon, C.P. 66460, Mexico
Tel: +52-55-3067-7521

Europe

23 Europe FA Center
Mitsubishi Electric Europe B.V. Polish Branch

ul. Krakowska 48, 32-083 Balice, Poland
Tel: +48-12-347-65-81

24 Germany FA Center
Mitsubishi Electric Europe B.V. German Branch

Mitsubishi-Electronic-Platz 1, 40882 Ratingen, Germany
Tel: +49-2102-486-0

25 UK FA Center
Mitsubishi Electric Europe B.V. UK Branch

Travellers Lane, Hatfield, Hertfordshire, AL10 8XB, U.K.
Tel: +44-1707-27-8780

26 Italy FA Center
Mitsubishi Electric Europe B.V. Italian Branch

Centro Direzionale Colleoni - Palazzo Sirio, Viale Colleoni 7, 20864 Agrate Brianza (MB), Italy
Tel: +39-039-60531

27 Czech Republic FA Center
Mitsubishi Electric Europe B.V. Czech Branch

Pekarska 621/7, 155 00 Praha 5, Czech Republic
Tel: +420-255 719 200

28 Russia FA Center
Mitsubishi Electric (Russia) LLC St.
Petersburg Branch

Piskarevsky pr. 2, bld 2, lit "Sch", BC "Benua", office 720; 195027, St. Petersburg, Russia
Tel: +7-812-633-3497

29 Turkey FA Center
Mitsubishi Electric Turkey A.S. Umraniye Branch

Serifali Mahallesi Nutuk Sokak No:5, TR-34775 Umraniye / Istanbul, Turkey
Tel: +90-216-526-3990

MEMO

Warranty

General-purpose AC servo

1. Warranty period and coverage

We will repair any failure or defect hereinafter referred to as "failure" in our FA equipment hereinafter referred to as the "Product" arisen during warranty period at no charge due to causes for which we are responsible through the distributor from which you purchased the Product or our service provider. However, we will charge the actual cost of dispatching our engineer for an on-site repair work on request by customer in Japan or overseas countries. We are not responsible for any on-site readjustment and/or trial run that may be required after a defective unit is repaired or replaced.

[Term]

The term of warranty for Product is twelve (12) months after your purchase or delivery of the Product to a place designated by you or eighteen (18) months from the date of manufacture whichever comes first ("Warranty Period"). Warranty period for repaired Product cannot exceed beyond the original warranty period before any repair work.

[Limitations]

- (1) You are requested to conduct an initial failure diagnosis by yourself, as a general rule.
It can also be carried out by us or our service company upon your request and the actual cost will be charged.
However, it will not be charged if we are responsible for the cause of the failure.
- (2) This limited warranty applies only when the condition, method, environment, etc. of use are in compliance with the terms and conditions and instructions that are set forth in the instruction manual and user manual for the Product and the caution label affixed to the Product.
- (3) Even during the term of warranty, the repair cost will be charged on you in the following cases;
 - (i) a failure caused by your improper storing or handling, carelessness or negligence, etc., and a failure caused by your hardware or software problem
 - (ii) a failure caused by any alteration, etc. to the Product made on your side without our approval
 - (iii) a failure which may be regarded as avoidable, if your equipment in which the Product is incorporated is equipped with a safety device required by applicable laws and has any function or structure considered to be indispensable according to a common sense in the industry
 - (iv) a failure which may be regarded as avoidable if consumable parts designated in the instruction manual, etc. are duly maintained and replaced
 - (v) any replacement of consumable parts (battery, fan, smoothing capacitor, etc.)
 - (vi) a failure caused by external factors such as inevitable accidents, including without limitation fire and abnormal fluctuation of voltage, and acts of God, including without limitation earthquake, lightning and natural disasters
 - (vii) a failure generated by an unforeseeable cause with a scientific technology that was not available at the time of the shipment of the Product from our company
 - (viii) any other failures which we are not responsible for or which you acknowledge we are not responsible for

2. Term of warranty after the stop of production

- (1) We may accept the repair at charge for another seven (7) years after the production of the product is discontinued. The announcement of the stop of production for each model can be seen in our Sales and Service, etc.
- (2) Please note that the Product (including its spare parts) cannot be ordered after its stop of production.

3. Service in overseas countries

Our regional FA Center in overseas countries will accept the repair work of the Product. However, the terms and conditions of the repair work may differ depending on each FA Center. Please ask your local FA Center for details.

4. Exclusion of loss in opportunity and secondary loss from warranty liability

Regardless of the gratis warranty term, Mitsubishi shall not be liable for compensation to:

- (1) Damages caused by any cause found not to be the responsibility of Mitsubishi.
- (2) Loss in opportunity, lost profits incurred to the user by Failures of Mitsubishi products.
- (3) Special damages and secondary damages whether foreseeable or not, compensation for accidents, and compensation for damages to products other than Mitsubishi products.
- (4) Replacement by the user, maintenance of on-site equipment, start-up test run and other tasks.

5. Change of Product specifications

Specifications listed in our catalogs, manuals or technical documents may be changed without notice.

6. Application and use of the Product

- (1) For the use of our General-Purpose AC Servo, its applications should be those that may not result in a serious damage even if any failure or malfunction occurs in General-Purpose AC Servo, and a backup or fail-safe function should operate on an external system to General-Purpose AC Servo when any failure or malfunction occurs.
- (2) Our General-Purpose AC Servo is designed and manufactured as a general purpose product for use at general industries. Therefore, applications substantially influential on the public interest for such as atomic power plants and other power plants of electric power companies, and also which require a special quality assurance system, including applications for railway companies and government or public offices are not recommended, and we assume no responsibility for any failure caused by these applications when used.
In addition, applications which may be substantially influential to human lives or properties for such as airlines, medical treatments, railway service, incineration and fuel systems, man-operated material handling equipment, entertainment machines, safety machines, etc. are not recommended, and we assume no responsibility for any failure caused by these applications when used.
We will review the acceptability of the abovementioned applications, if you agree not to require a specific quality for a specific application. Please contact us for consultation.

Servo system controller

1. Warranty period and coverage

We will repair any failure or defect (hereinafter referred to as "failure") in our FA equipment (hereinafter referred to as the "Product") arisen during warranty period at no charge due to causes for which we are responsible through the distributor from which you purchased the Product or our service provider. However, we will charge the actual cost of dispatching our engineer for an on-site repair work on request by customer in Japan or overseas countries. We are not responsible for any on-site readjustment and/or trial run that may be required after a defective unit is repaired or replaced.

[Term]

The term of warranty for Product is thirty six (36) months after your purchase or delivery of the Product to a place designated by you or forty two (42) months from the date of manufacture whichever comes first ("Warranty Period"). Warranty period for repaired Product cannot exceed beyond the original warranty period before any repair work.

[Limitations]

- (1) You are requested to conduct an initial failure diagnosis by yourself, as a general rule.
It can also be carried out by us or our service company upon your request and the actual cost will be charged.
However, it will not be charged if we are responsible for the cause of the failure.
- (2) This limited warranty applies only when the condition, method, environment, etc. of use are in compliance with the terms and conditions and instructions that are set forth in the instruction manual and user manual for the Product and the caution label affixed to the Product.
- (3) Even during the term of warranty, the repair cost will be charged on you in the following cases;
 - (i) a failure caused by your improper storing or handling, carelessness or negligence, etc., and a failure caused by your hardware or software problem
 - (ii) a failure caused by any alteration, etc. to the Product made on your side without our approval
 - (iii) a failure which may be regarded as avoidable, if your equipment in which the Product is incorporated is equipped with a safety device required by applicable laws and has any function or structure considered to be indispensable according to a common sense in the industry
 - (iv) a failure which may be regarded as avoidable if consumable parts designated in the instruction manual, etc. are duly maintained and replaced
 - (v) any replacement of consumable parts (battery, fan, etc.)
 - (vi) a failure caused by external factors such as inevitable accidents, including without limitation fire and abnormal fluctuation of voltage, and acts of God, including without limitation earthquake, lightning and natural disasters
 - (vii) a failure generated by an unforeseeable cause with a scientific technology that was not available at the time of the shipment of the Product from our company
 - (viii) any other failures which we are not responsible for or which you acknowledge we are not responsible for

2. Term of warranty after the stop of production

- (1) We may accept the repair at charge for another seven (7) years after the production of the product is discontinued. The announcement of the stop of production for each model can be seen in our Sales and Service, etc.
- (2) Please note that the Product (including its spare parts) cannot be ordered after its stop of production.

3. Service in overseas countries

Our regional FA Center in overseas countries will accept the repair work of the Product. However, the terms and conditions of the repair work may differ depending on each FA Center. Please ask your local FA Center for details.

4. Exclusion of loss in opportunity and secondary loss from warranty liability

Regardless of the gratis warranty term, Mitsubishi shall not be liable for compensation to:

- (1) Damages caused by any cause found not to be the responsibility of Mitsubishi.
- (2) Loss in opportunity, lost profits incurred to the user by Failures of Mitsubishi products.
- (3) Special damages and secondary damages whether foreseeable or not, compensation for accidents, and compensation for damages to products other than Mitsubishi products.
- (4) Replacement by the user, maintenance of on-site equipment, start-up test run and other tasks.

5. Change of Product specifications

Specifications listed in our catalogs, manuals or technical documents may be changed without notice.

6. Application and use of the Product

- (1) For the use of our Motion controller/Simple Motion module, its applications should be those that may not result in a serious damage even if any failure or malfunction occurs in Motion controller/Simple Motion module, and a backup or fail-safe function should operate on an external system to Motion controller/Simple Motion module when any failure or malfunction occurs.
- (2) Our Motion controller/Simple Motion module are designed and manufactured as general purpose product for use at general industries.
Therefore, applications substantially influential on the public interest for such as atomic power plants and other power plants of electric power companies, and also which require a special quality assurance system, including applications for railway companies and government or public offices are not recommended, and we assume no responsibility for any failure caused by these applications when used.
In addition, applications which may be substantially influential to human lives or properties for such as airlines, medical treatments, railway service, incineration and fuel systems, man-operated material handling equipment, entertainment machines, safety machines, etc. are not recommended, and we assume no responsibility for any failure caused by these applications when used.
We will review the acceptability of the abovementioned applications, if you agree not to require a specific quality for a specific application. Please contact us for consultation.

Microsoft, Windows , Internet Explorer, and Windows Vista are either registered trademarks or trademarks of Microsoft Corporation in the United States and/or other countries. Ethernet is a trademark of Xerox Corporation. All other company names and product names used in this document are trademarks or registered trademarks of their respective companies.

Precautions before use

This publication explains the typical features and functions of the products herein and does not provide restrictions or other information related to usage and module combinations. Before using the products, always read the product user manuals. Mitsubishi Electric will not be held liable for damage caused by factors found not to be the cause of Mitsubishi Electric; opportunity loss or lost profits caused by faults in Mitsubishi Electric products; damage, secondary damage, or accident compensation, whether foreseeable or not, caused by special factors; damage to products other than Mitsubishi Electric products; or any other duties.

For safe use

- To use the products given in this publication properly, always read the relevant manuals before beginning operation.
- The products have been manufactured as general-purpose parts for general industries, and are not designed or manufactured to be incorporated in a device or system used in purposes related to human life.
- Before using the products for special purposes such as nuclear power, electric power, aerospace, medicine or passenger-carrying vehicles, consult with Mitsubishi Electric.
- The products have been manufactured under strict quality control. However, when installing the products where major accidents or losses could occur if the products fail, install appropriate backup or fail-safe functions in the system.

YOUR SOLUTION PARTNER

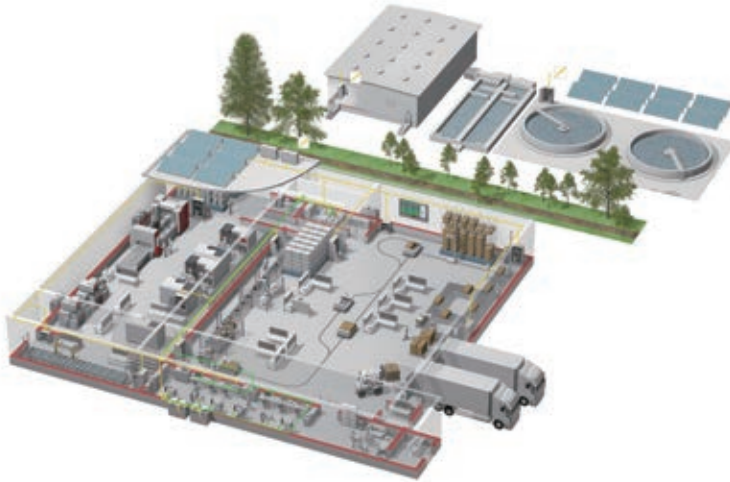

Mitsubishi Electric offers a wide range of automation equipment from PLCs and HMIs to CNC and EDM machines.

A NAME TO TRUST

Since its beginnings in 1870, some 45 companies use the Mitsubishi name, covering a spectrum of finance, commerce and industry.

The Mitsubishi brand name is recognized around the world as a symbol of premium quality.

Mitsubishi Electric Corporation is active in space development, transportation, semi-conductors, energy systems, communications and information processing, audio visual equipment and home electronics, building and energy management and automation systems, and has 237 factories and laboratories worldwide in over 121 countries.

This is why you can rely on Mitsubishi Electric automation solution - because we know first hand about the need for reliable, efficient, easy-to-use automation and control in our own factories.

As one of the world's leading companies with a global turnover of over 4 trillion Yen (over \$40 billion), employing over 100,000 people, Mitsubishi Electric has the resource and the commitment to deliver the ultimate in service and support as well as the best products.



Low voltage: MCCB, MCB, ACB



Medium voltage: VCB, VCC



Power monitoring, energy management



Compact and Modular Controllers



Inverters, Servos and Motors



Visualisation: HMIs



Numerical Control (NC)



Robots: SCARA, Articulated arm



Processing machines: EDM, Lasers, IDS



Transformers, Air conditioning, Photovoltaic systems

* Not all products are available in all countries.

Mitsubishi Servo System Family Catalog

Country/Region	Sales office	Tel
USA	Mitsubishi Electric Automation, Inc. 500 Corporate Woods Parkway, Vernon Hills, IL 60061, U.S.A.	Tel : +1-847-478-2100
Mexico	Mitsubishi Electric Automation, Inc. Mexico Branch Boulevard Miguel de Cervantes Saavedra 301, Torre Norte Piso 5, Ampliacion Granada, Miguel Hidalgo, Ciudad de Mexico, Mexico, C.P.11520	Tel : +52-55-3067-7512
Brazil	Mitsubishi Electric do Brasil Comercio e Servicos Ltda. Avenida Adelino Cardana, 293, 21 andar, Bethaville, Barueri SP, Brazil	Tel : +55-11-4689-3000
Germany	Mitsubishi Electric Europe B.V. German Branch Mitsubishi-Electric-Platz 1, 40882 Ratingen, Germany	Tel : +49-2102-486-0
UK	Mitsubishi Electric Europe B.V. UK Branch Travellers Lane, UK-Hatfield, Hertfordshire, AL10 8XB, U.K.	Tel : +44-1707-28-8780
Italy	Mitsubishi Electric Europe B.V. Italian Branch Centro Direzionale Colleoni - Palazzo Sirio, Viale Colleoni 7, 20864 Agrate Brianza (MB), Italy	Tel : +39-039-60531
Spain	Mitsubishi Electric Europe B.V. Spanish Branch Carretera de Rubi, 76-80-Apdo. 420, E-08190 Sant Cugat del Valles (Barcelona), Spain	Tel : +34-935-65-3131
France	Mitsubishi Electric Europe B.V. French Branch 25, Boulevard des Bouvets, 92741 Nanterre Cedex, France	Tel : +33-1-55-68-55-68
Czech Republic	Mitsubishi Electric Europe B.V. Czech Branch, Prague Office Pekarska 621/7, 155 00 Praha 5, Czech Republic	Tel : +420-255-719-200
Poland	Mitsubishi Electric Europe B.V. Polish Branch ul. Krakowska 50, 32-083 Balice, Poland	Tel : +48-12-347-65-00
Russia	Mitsubishi Electric (Russia) LLC St. Petersburg Branch Piskarevsky pr. 2, bld 2, lit "Sch", BC "Benua", office 720; 195027 St. Petersburg, Russia	Tel : +7-812-633-3497
Sweden	Mitsubishi Electric Europe B.V. (Scandinavia) Fjellievagen 8, SE-22736 Lund, Sweden	Tel : +46-8-625-10-00
Turkey	Mitsubishi Electric Turkey A.S. Umraniye Branch Serifali Mahallesi Nutuk Sokak No:5, TR-34775 Umraniye / Istanbul, Turkey	Tel : +90-216-526-3990
UAE	Mitsubishi Electric Europe B.V. Dubai Branch Dubai Silicon Oasis, P.O.BOX 341241, Dubai, U.A.E.	Tel : +971-4-3724716
South Africa	Adroit Technologies 20 Waterford Office Park, 189 Witkoppen Road, Fourways, South Africa	Tel : +27-11-658-8100
China	Mitsubishi Electric Automation (China) Ltd. Mitsubishi Electric Automation Center, No.1386 Hongqiao Road, Shanghai, China	Tel : +86-21-2322-3030
Taiwan	SETSUYO ENTERPRISE CO., LTD. 6F, No.105, Wugong 3rd Road, Wugong District, New Taipei City 24889, Taiwan	Tel : +886-2-2299-2499
Korea	Mitsubishi Electric Automation Korea Co., Ltd. 7F to 9F, Gangseo Hangang Xi-tower A, 401, Yangcheon-ro, Gangseo-Gu, Seoul 07528, Korea	Tel : +82-2-3660-9529
Singapore	Mitsubishi Electric Asia Pte. Ltd. 307 Alexandra Road, Mitsubishi Electric Building, Singapore 159943	Tel : +65-6473-2308
Thailand	Mitsubishi Electric Factory Automation (Thailand) Co., Ltd. 12th Floor, SV.City Building, Office Tower 1, No. 896/19 and 20 Rama 3 Road, Kwaeng Bangpongpan, Khet Yannawa, Bangkok 10120, Thailand	Tel : +66-2682-6522 to 6531
Indonesia	PT. Mitsubishi Electric Indonesia Gedung Jaya 8th Floor, JL. MH. Thamrin No.12, Jakarta Pusat 10340, Indonesia	Tel : +62-21-3192-6461
Vietnam	Mitsubishi Electric Vietnam Company Limited Unit 01-04, 10th Floor, Vincom Center, 72 Le Thanh Ton Street, District 1, Ho Chi Minh City, Vietnam	Tel : +84-28-3910-5945
India	Mitsubishi Electric India Pvt. Ltd. Pune Branch Emerald House, EL-3, J Block, M.I.D.C., Bhosari, Pune - 411026, Maharashtra, India	Tel : +91-20-2710-2000
Australia	Mitsubishi Electric Australia Pty. Ltd. 348 Victoria Road, P.O. Box 11, Rydalmere, N.S.W 2116, Australia	Tel : +61-2-9684-7777

Mitsubishi Electric Corporation Nagoya Works is a factory certified for ISO 14001 (standards for environmental management systems) and ISO 9001 (standards for quality assurance management systems).

MITSUBISHI ELECTRIC CORPORATION

HEAD OFFICE: TOKYO BUILDING, 2-7-3, MARUNOUCHI, CHIYODA-KU, TOKYO 100-8310, JAPAN
NAGOYA WORKS: 1-14, YADA-MINAMI 5, HIGASHI-KU, NAGOYA, JAPAN